



QUALIFIED WATER EFFICIENT LANDSCAPER

REFERENCE MANUAL

VERSION: SONOMA-MARIN SAVING WATER PARTNERSHIP



**INTRODUCTION
and
ACKNOWLEDGMENTS**





THE SONOMA-MARIN SAVING WATER PARTNERSHIP

The Sonoma-Marin Saving Water Partnership (Partnership) is the parent Professional Certifying Organization (PCO) for the Qualified Water Efficient Landscaper (QWEL) professional certification in irrigation system audits.

The Partnership represents 10 water utilities in Sonoma and Marin counties that have joined together to provide regional solutions for water use efficiency. The utilities include the Cities of Santa Rosa, Rohnert Park, Petaluma, Sonoma, Cotati; North Marin, Valley of the Moon and Marin Municipal Water Districts; Town of Windsor, and Sonoma County Water Agency (Partners). Each of the Partners have water conservation programs that can assist customers in reducing their water use. The Partnership was formed to identify and recommend implementation of water use efficiency projects, and maximize the cost-effectiveness of water use efficiency programs in our region.

The Partnership has received national recognition from the U.S. Environmental Protection Agency (EPA) WaterSense program with seven awards in five years for continued efforts in promoting water use efficiency in our region and beyond.

For three consecutive years (2014-16) the Partnership has been the recipient of the Professional Certifying Partner of the Year award for its work in educating landscape professionals through its WaterSense labeled QWEL professional certification program. In 2017, the Partnership was the recipient of its first Sustained Excellence Award.



The QWEL program was developed in 2007 by Sonoma County Water Agency in partnership with the North Coast Chapter of the California Landscape Contractors Association, local landscape maintenance contractors, local water retailers, and academia. Since 2007, the QWEL program has been adopted by over 20 Professional Certifying Organizations (PCOs) throughout the U.S.

THE QUALIFIED WATER EFFICIENT LANDSCAPER TRAINING PROGRAM

MISSION STATEMENT

The Qualified Water Efficient Landscaper training presents an affordable proactive local approach to reducing landscape water demand. QWEL provides graduates with knowledge in water efficient and sustainable landscape practices, including water management and preservation of other valuable resources.

The QWEL professional certification in irrigation system audits provides landscape professionals with 20 hours of education on local water supply, sustainable landscaping, soils, water budgeting and water management, irrigation system components and maintenance, irrigation system audits, and scheduling and controller programming. QWEL is recognized as an EPA WaterSense labeled Professional Certification Program for Irrigation System Audits.

The list of topics covered in the 2017 QWEL curriculum include:

1. Where Our Water Comes From
 2. Sustainable Landscaping
 3. Soils
 4. Landscape Water
 5. Irrigation Systems
 6. Irrigation Maintenance & Trouble Shooting
 7. Irrigation System Auditing
 8. Irrigation Scheduling
 9. Irrigation Controllers
 10. Bringing It All Together
-

BECOME A QWEL CERTIFIED PROFESSIONAL

In order to become a QWEL certified professional an individual must:

1. Pass the QWEL exam (75% pass rate).
 2. Complete an irrigation system audit using the QWEL irrigation audit form.
 3. Maintain certification with two hours of continuing education units (CEUs) each calendar year.
-

QWEL training is offered by many Professional Certifying Organizations (PCOs) in the U.S. PCOs provide training classes with a certified instructor, as well as the opportunity to take the QWEL exam and conduct an irrigation system audit. Visit the QWEL website to see if QWEL is offered in your area. Information for organizations interested in becoming a QWEL Professional Certifying Organization is provided on the QWEL website.

www.QWEL.net

TERMS OF USE

The QWEL program provides educational materials designed to provide a better understanding of landscape water management for the landscape industry. Please honor the QWEL and WaterSense label and preserve the integrity of the QWEL curriculum by not altering the content.

If the QWEL curriculum is used to achieve the QWEL professional certification the course content must be taught in its entirety. For more information on QWEL, please visit the QWEL website or contact the QWEL Program Manager.

QWEL materials and logo are copyright protected and may not be used without the express written consent of the QWEL Board of Directors.

©2008, 2012, 2018 Sonoma-Marín Saving Water Partnership

QWEL Program Manager
Gregory Plumb
Sonoma County Water Agency
404 Aviation Blvd, Santa Rosa, CA 95403
Phone: 707.547.1933
www.QWEL.net

QWEL BOARD OF DIRECTORS

CO-CHAIRS

Carrie Pollard, Water Use Efficiency Manager, Sonoma County Water Agency
Peter Estournes, Vice President/COO Gardenworks, Inc.

MEMBERS AT LARGE

Deb Lane, Water Resources Analyst, City of Santa Rosa
Carlos Michelin, Principal Water Resources Specialist, San Diego County Water Authority
Chris McNairy, Northern California Sales Manager, Hunter Industries

ACKNOWLEDGMENTS FOR THE 2018 QWEL CURRICULUM

CONTRIBUTORS

PROJECT MANAGER

Gregory Plumb, Water Use Efficiency Specialist, Sonoma County Water Agency

REVIEWERS AND CONTRIBUTORS

Courtney Brown, Jordan Valley Water Conservancy District, UT
Brandon Burgess, Chino Basin Water Conservation District, CA
Peter Estournes, Gardenworks, Inc., CA
Susan Foley, UC Master Gardeners of Sonoma County, CA
Joel Grogan, Santa Rosa Junior College, CA
Betty Hylton, Mammoth Community Water District, CA
Scott Kleinrock, Chino Basin Water Conservation District, CA
Kelly Kopp, Utah State University, UT
Deb Lane, City of Santa Rosa, CA
Brian Lee, Sonoma County Water Agency, CA
Kris Loomis, Sonoma County Water Agency, CA
Chris McNairy, Hunter Industries, CA
Carlos Michelon, San Diego County Water Authority, CA
Robyn Navarra, Zone 7 Water Agency, CA
Carrie Pollard, Sonoma County Water Agency, CA
Lindsay Rogers, WaterNow Alliance, CA
Larry Rupp, Utah State University, UT
Candace Schaible, Utah State University, UT
Nicholas Schneider, Mojave Water, CA
Katelyn Scholte, San Bernardino Valley Water Conservation District, CA
Jana Vierola, San Diego County Water Authority, CA

CONTRIBUTORS TO THE ORIGINAL QWEL CURRICULUM

Fernando Agudelo-Silva, Kimberly Bertotti, Charlene Burgi, Quin Ellis, Ali Davidson, Peter Estournes, Dave Iribarne, Dan Kahane, Dave Kaplow, Deb Lane, Daniel Muelrath, Dave Penry, Michael Smith, Jay Tripathi

IMAGES AND DATA

A & L Western Agricultural Laboratories, California Irrigation Management Information System, City of Santa Monica, City of Santa Rosa, EPA WaterSense, Growing Life, Hunter Industries Inc, Irrrometer Company, Inc, Irritrol, Metropolitan Water Company of Southern California, Netafim USA, Nibco, Orbit Irrigation Products, Inc, Rachio, Inc, Rain Bird Corporation, San Diego County Water Authority, Soil Quality Pty Ltd, The Toro Company, United States Department of Agriculture, United States Geological Survey, Utah State University, Water Research Foundation, Water Use Classification of Landscape Species, Watts, Zurn.

TABLE OF CONTENTS

Section 1: WHERE OUR WATER COMES FROM.....	1-1
Section 2: SUSTAINABLE LANDSCAPING.....	2-1
Section 3: SOILS	3-1
Section 4: LANDSCAPE WATER	4-1
Section 5: IRRIGATION SYSTEMS	5-1
Section 6: IRRIGATION MAINTENANCE & TROUBLESHOOTING	6-1
Section 7: IRRIGATION SYSTEM AUDITING	7-1
Section 8: IRRIGATION SCHEDULING.....	8-1
Section 9: IRRIGATION CONTROLLERS	9-1
Section 10: BRINGING IT ALL TOGETHER.....	10-1
Appendix: IRRIGATION AUDIT EXERCISE FORM	A-1
QWEL EXAM FORMULA SHEET	A-7



Section 1:
**WHERE OUR WATER
COMES FROM**





WHERE OUR WATER COMES FROM

Learning Objectives

1. Understand the water cycle and the concept of a watershed
2. Understand the big picture of water supply in California
3. Understand water supply sources in Sonoma and Marin Counties
4. Understand how we use water
5. Be knowledgeable about California water law
6. Be knowledgeable of national and statewide programs for water use efficiency
7. Be knowledgeable of local utility sponsored programs for water use efficiency
8. Be able to read water meters, understand their uses, and perform basic leak detection

1 WATER CYCLE AND WATERSHED

1.1 The **water cycle** (Figure 1-1) is essential to understanding where your water comes from and how water moves between the earth's land, atmosphere, and oceans.

- **Evaporation** occurs when the sun's energy turns liquid water on the earth's surface into water vapor, which enters the atmosphere. Water vapor leaves plants in a process called **transpiration**. Together, they are called **evapotranspiration**.
- The water vapor in the atmosphere cools to form clouds (**condensation**).
- Through **precipitation** in the form of rain or snow, the water returns to earth.
- Water:
 - **Evaporates** from surfaces.
 - **Transpires** from plants.
 - **Infiltrates** into the ground.
 - **Recharges** groundwater.
 - **Runs off** into creeks, rivers, and lakes.

Figure 1-1: Water cycle

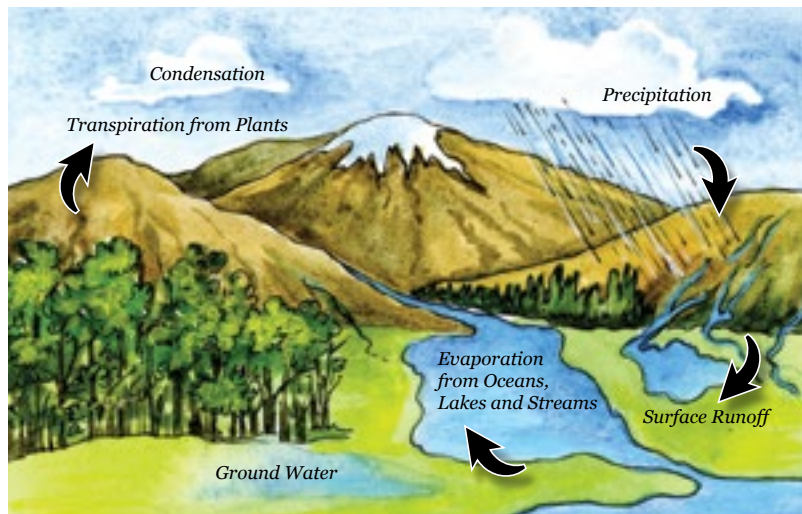
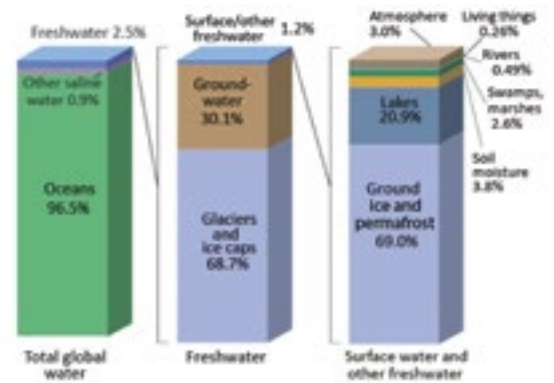

Figure 1-2: Distribution of earth's water (image courtesy of USGS)



Source: Igor Shikomanov's chapter "World fresh water resources" in Peter H. Gleick (editor), 1993, *Water in Crisis: A Guide to the World's Fresh Water Resources*. NOTE: Numbers are rounded, so percent summations may not add to 100.

- Distribution of the earth's water supplies (Figure 1-2):¹
 - Over 96% of the earth's water is salt water (saline).
 - Over 68% of freshwater is contained in ice and glaciers.
 - 30% of freshwater is in the ground.
 - Less than 0.3% of freshwater is contained in lakes and rivers.

¹<https://water.usgs.gov/edu/earthwherewater.html>

- 1.2 A **watershed** (Figure 1-3) is all of the land that drains to a single water body such as a creek, river, lake, or ocean. Watersheds are often named after the water body that they drain into.
- Watersheds determine where water flows and infiltrates into the ground.
 - The concept of a watershed can be used for large areas of land that are made up of sub watersheds or can be focused to an area as small as a residential lot.
 - Watersheds are important for water supply, storm water management, and sustainable landscaping.

Figure 1-3: Watershed

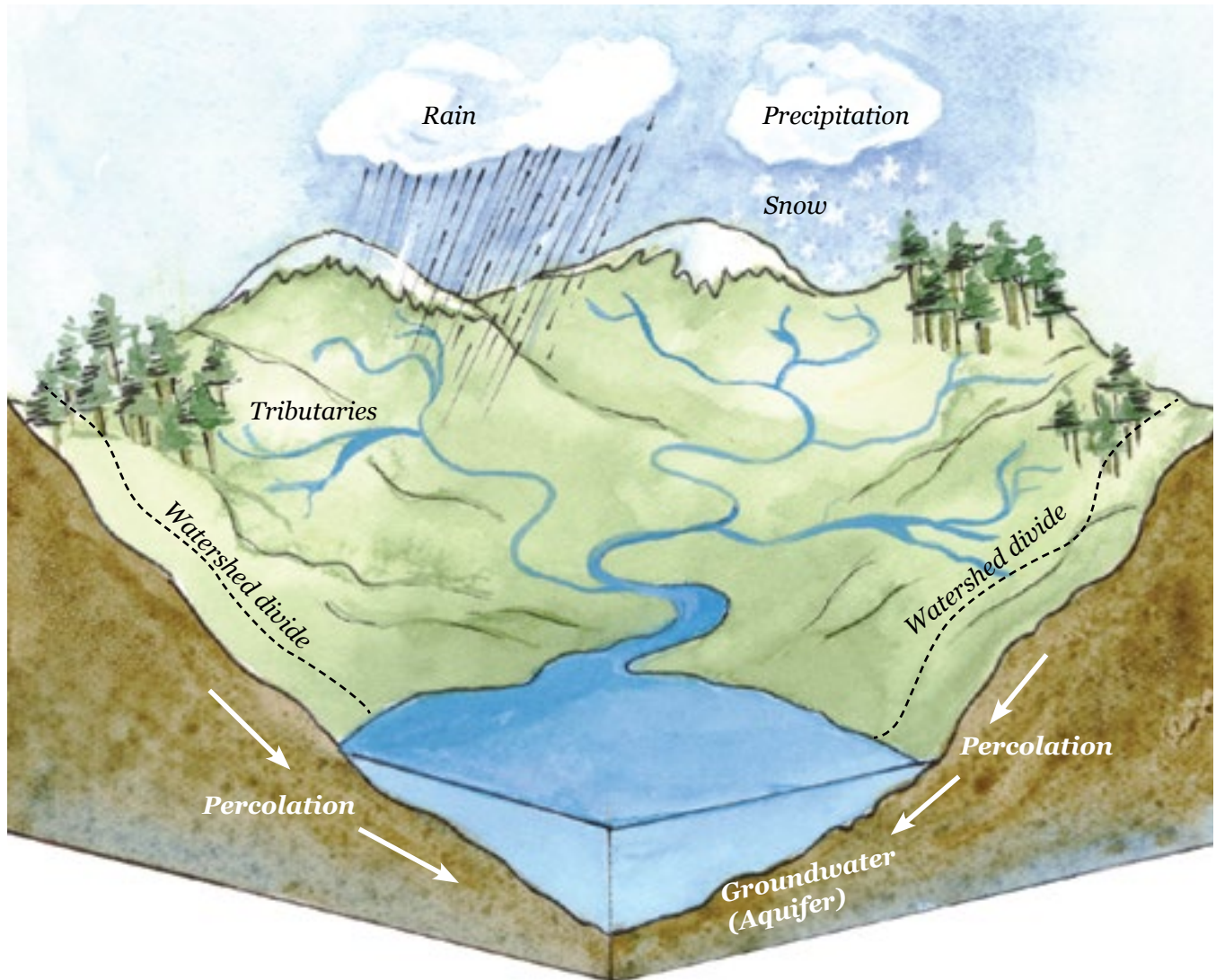

2 WATER SUPPLY IN CALIFORNIA

- 2.1 In California we rely on [snow melt](#) from the Sierras, [rainwater](#) runoff into reservoirs, and [groundwater](#).
- The majority of precipitation occurs between October and April, yet water demand is highest during the summer months.
- 2.2 California's climate is highly variable and is prone to cyclical [periods of drought](#), as shown by the orange bars in Figure 1-4.

Figure 1-4: Palmer drought severity index, 1895 - 2014

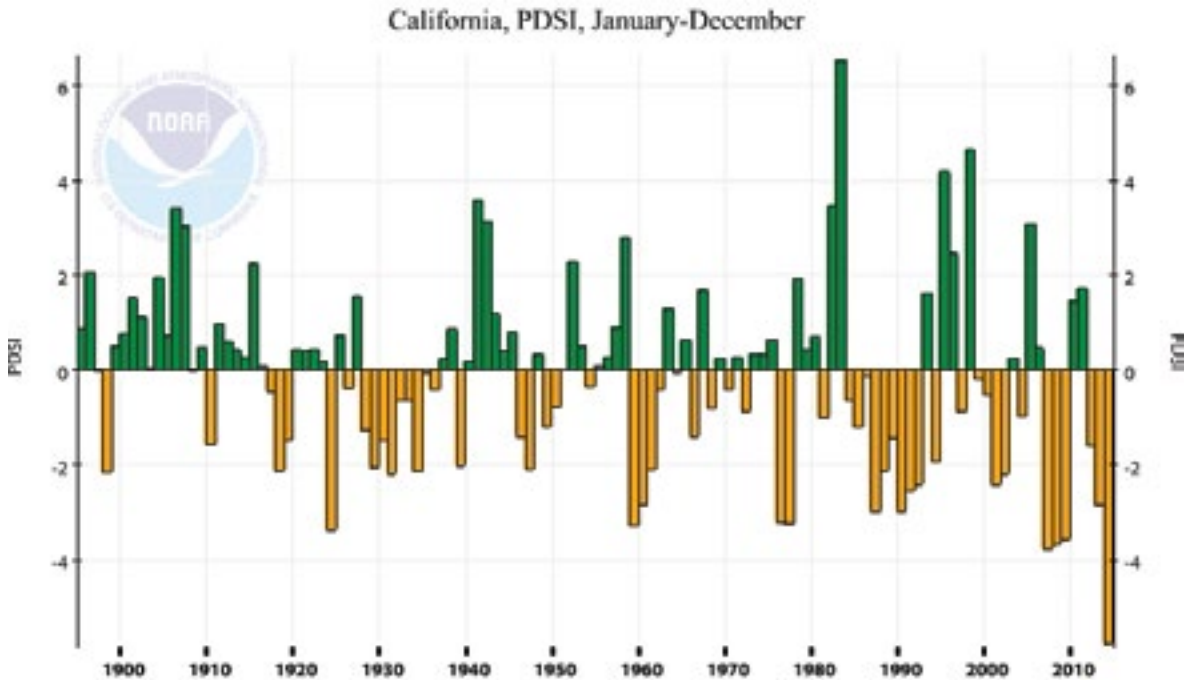

- 2.3 Continued [population](#) growth highlights the importance of water conservation. As of July 2016, the [population](#) of California was more than [39 million](#).² California is forecast to reach 50 million during 2055.³
- California has an aging population.
 - Continued population growth is forecast due to migration into the state.
- 2.4 California has built a water system to move water around the state (Figure 1-5).
- The [Central Valley Project](#) (CVP) provides irrigation and municipal water to much of California's Central Valley. Water is stored in reservoirs at various locations, including Shasta Lake and Trinity Lake.
 - The CVP delivers about 7 million acre-feet of water a year on average.
 - The [State Water Project](#) (SWP) conveys water from Lake Oroville in Northern California to the Bay Area, the southern San Joaquin Valley, and Southern California.
 - The SWP delivers about 2.4 million acre-feet of water a year on average.
 - California holds entitlements to 4.4 million acre-feet of water from the [Colorado River](#) delivered to the Imperial Valley, Coachella Valley, and Southern California by two separate systems.

²U.S. Census Bureau

³California Department of Finance, March 8, 2017.

Figure 1-5: Water supply and storage in California

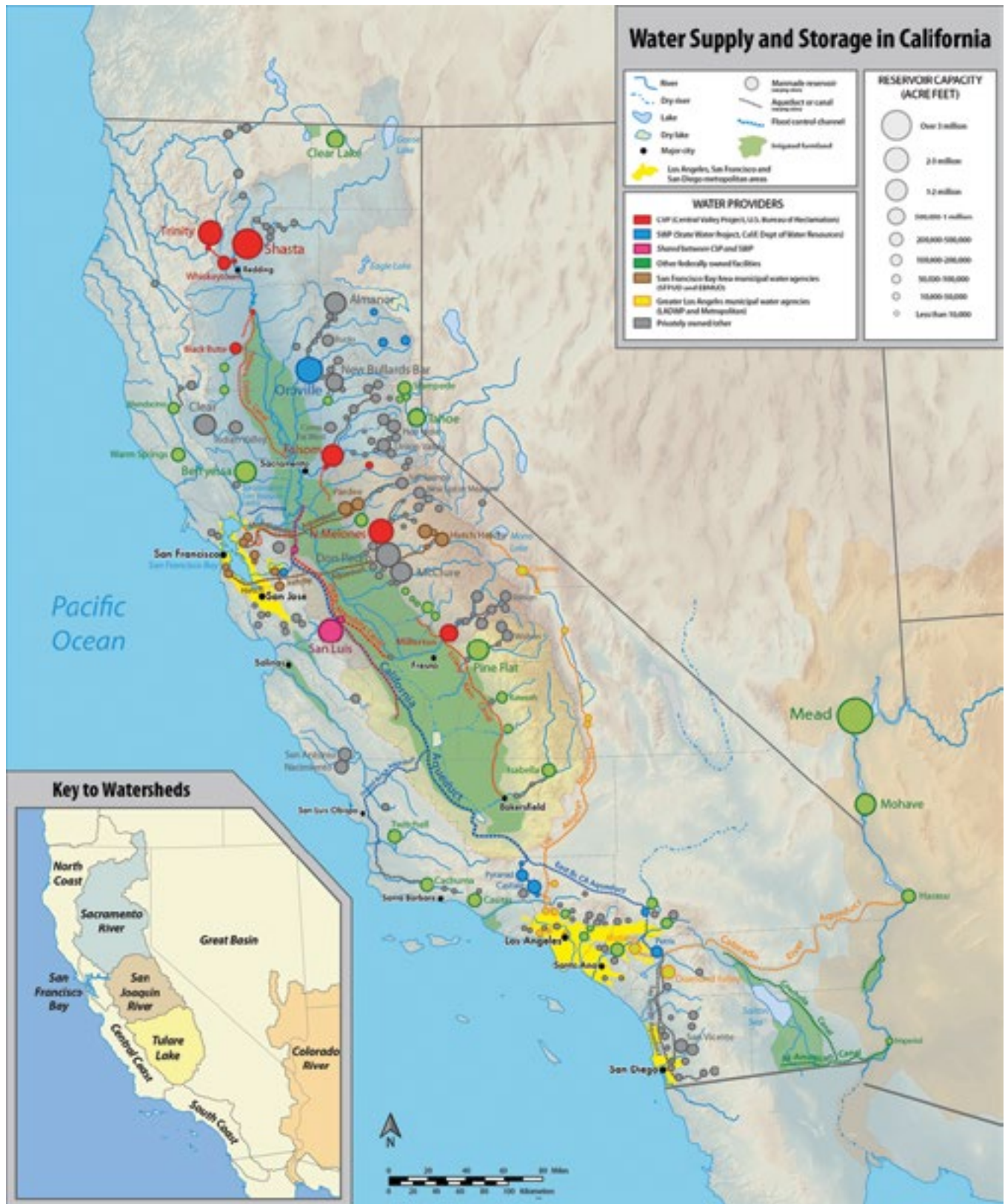
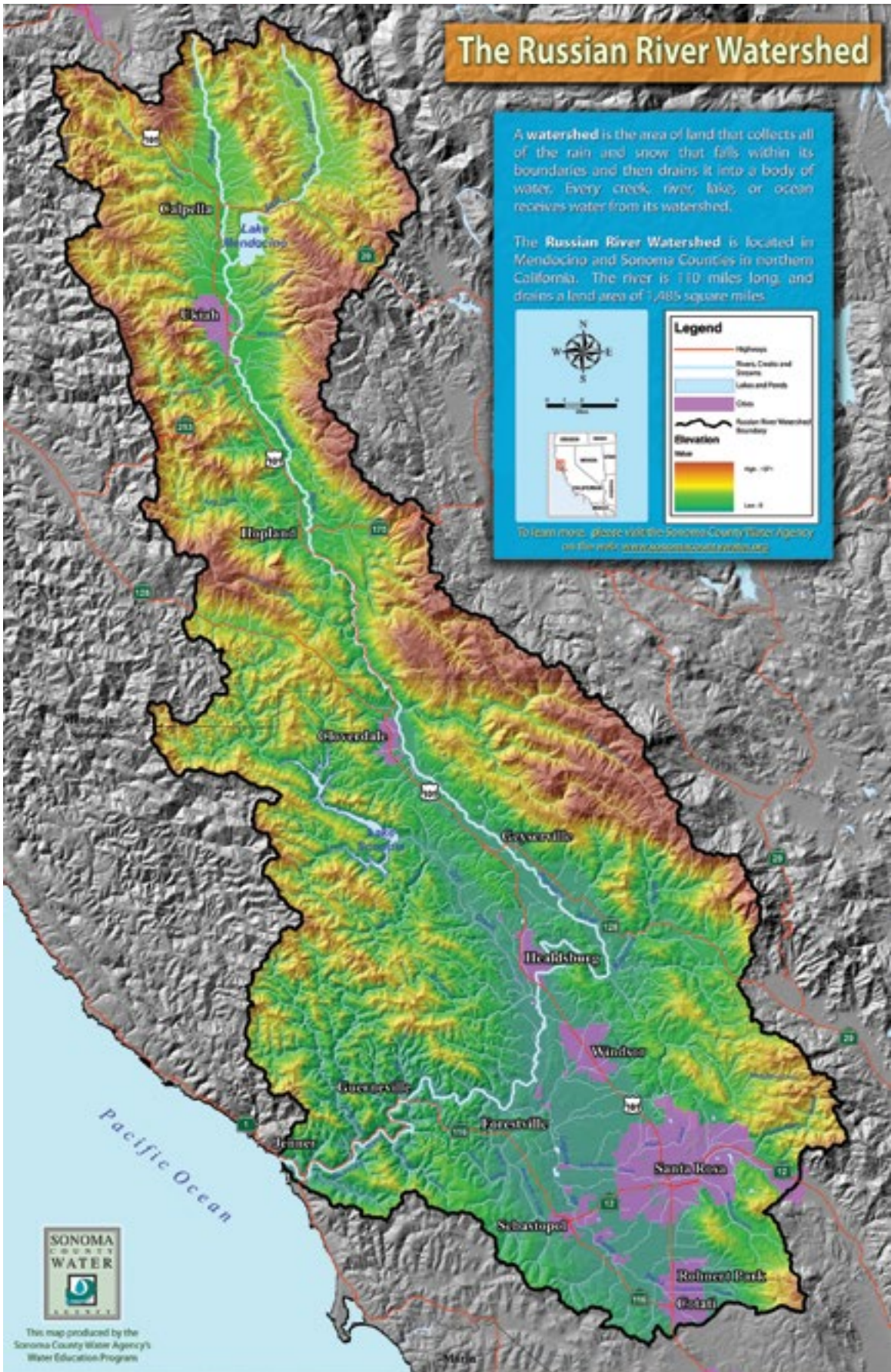

Figure 1-6: Russian River system



3 WATER SUPPLY IN SONOMA & MARIN COUNTIES

- 3.1 The **Russian River** originates in northern Mendocino County and flows for 116 miles through 1,485 square miles of watershed before it reaches the Pacific Ocean at Jenner, 20 miles west of Santa Rosa (Figure 1-6).
- There are five main tributaries: the East Fork of the Russian River, Big Sulphur Creek, Mark West Creek, Maacama Creek, and Dry Creek.
 - Sonoma and Marin County watersheds receive their water primarily from rainfall with amounts ranging from 20 to 80 inches per year, averaging approximately 40 inches per year.



- 3.2 As a wholesale water provider the **Sonoma County Water Agency** (SCWA)⁴ provides potable water to nearly 600,000 people in Sonoma and Marin counties, as well as sanitation, flood protection, and stream maintenance services.
- The mission of SCWA is to effectively manage the resources in our care for the benefit of people and the environment through resource and environmental stewardship, technical innovation, and responsible fiscal management.

- 3.3 Two major reservoirs (**surface water**) provide water storage and flood protection for the Russian River Basin, in addition to maintaining the minimum required stream flows to provide habitat for the many species that inhabit the Russian River.
- **Lake Sonoma** and **Warm Spring Dam** on Dry Creek. Capacity of water supply pool 245,000 acre-feet.
 - **Lake Mendocino** and **Coyote Dam** on the East Fork of the Russian River. Capacity of water supply pool fluctuates between 68,400 and 111,000 acre-feet depending on the season.
- 3.4 The Russian River and its major tributaries are home to three species of fish that are threatened or endangered: **coho salmon** (endangered), **Chinook salmon** (threatened), and **steelhead trout** (threatened). SCWA is committed to improving the native fish resources and habitats of the Russian River watershed through a variety of projects including habitat restoration, water quality improvement, and fish life cycle monitoring.
- 3.5 **Diversion facilities** on the Russian River use an inflatable rubber dam to divert water into infiltration ponds where it is naturally filtered and recharges the underground aquifer. The naturally filtered water is pumped from 50 to 60 feet beneath the ground by six collector wells.
- 3.6 SCWA delivers water to **retail water agencies** including: the Town of Windsor; the Cities of Santa Rosa, Rohnert Park, Cotati, Petaluma, and Sonoma; and Valley of the Moon, North Marin, and Marin Municipal Water Districts.
- 3.7 **Groundwater** drawn from local aquifers is used by some retail water agencies to supplement water purchased from SCWA.
- 3.8 **Recycled water** is used by SCWA and some retail water agencies to irrigate landscapes, agricultural crops, vineyards, golf courses, parks, cemeteries, freeway embankments, and street medians. Recycled water is also used to recharge the Geysers project to produce electricity.
- Recycled water is wastewater that is highly treated through multiple levels of disinfection and treatment.
 - Recycled water will generally have a higher concentration of dissolved salts than drinking water.
 - Users of recycled water should understand the qualities of the water to



⁴ <http://www.scwa.ca.gov/>

ensure that it is appropriate for the proposed application.

- 3.9 **Water use efficiency** programs are an essential component of water supply. Providing education and incentives to homeowners and businesses to use water more efficiently reduces water demand and helps to ensure an adequate water supply.



3.10 **Marin Municipal Water District (MMWD)**⁵ owns and manages 18,500 acres, or 34 square miles, of the Mt. Tamalpais watershed stretching from southern Marin in Mill Valley to Lagunitas in San Geronimo Valley.

- Three tributaries on the north slope of Mt. Tamalpais, the East, Middle and West Forks of Lagunitas Creek, represent the headwaters of the Lagunitas Creek drainage.

3.11 MMWD Water Supply

- 75% comes from **surface water** stored in seven reservoirs with a total storage capacity of close to 80,000 acre-feet. The reservoirs are: Lake Lagunitas, Phoenix Lake, Alpine Lake, Bon Tempe Lake, Kent Lake, Nicasio, Walker Creek Watershed (Soulajule).
- 23% is imported from the Russian River Watershed via a pipeline under an agreement with SCWA.
- 2% comes from recycled water.

3.12 Private **well water** is not provided or tested by a municipal water supplier and is the responsibility of the individual property owner.

- Regular water quality testing is recommended to identify any plant or soil issues that might result from irrigating with private well water.

⁵ <https://www.marinwater.org/>

4 HOW WE USE WATER

4.1 Average annual residential water use in the United States is **88,000 gallons per household per year** (gphy).⁶

4.2 Average **indoor annual water use** in single-family homes is 50,000 gphy.

4.3 **Toilet flushing** is the largest indoor use of water in single-family homes, followed by faucets, showers, clothes washers, leaks, bathtubs, other/miscellaneous, and dishwashers (Figure 1-7).

Figure 1-7: Indoor household use by fixture (Water Research Foundation, 2016)









							
TOILET 24% 32.6 GPHD	FAUCET 20% 27.0 GPHD	SHOWER 20% 26.9 GPHD	CLOTHES WASHER 16% 22.0 GPHD	LEAK 13% 17.8 GPHD	BATH 3% 4.4 GPHD	OTHER* 3% 4.0 GPHD	DISHWASHER 2% 2.2 GPHD

Figure 1-8: Indoor and outdoor water use (Water Research Foundation, 2016)



4.4 **Outdoor use** is more variable than indoor use due to differences in climate and weather patterns.

- A typical home uses half of its water outdoors (Figure 1-8).
- A previous study indicates that a typical home in Sonoma and Marin Counties uses almost half of its water outdoors.⁷
- A 2014 study by the Pacific Institute and the Natural Resources Defense Council indicated potential annual outdoor water savings in the North Coast Region of California of 15,000 to 34,000 acre-feet through landscape conversions.⁸
- Landscape water management is a dynamic process requiring specific knowledge and the ability to react to changing site conditions and provide continuous monitoring.
- Understanding the plant-soil-water relationship is key to effective landscape water management and sustainable landscaping.

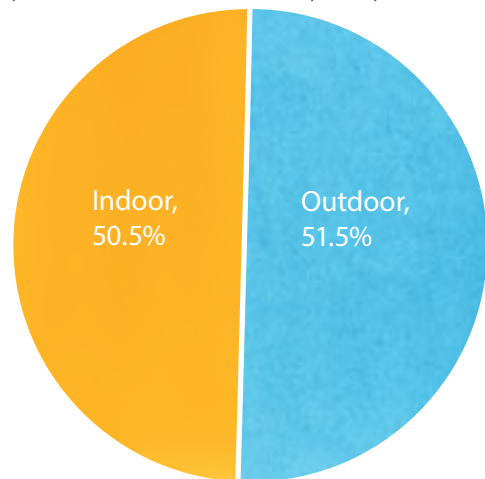
⁶ DeOreo, W.B. and Mayer, P.W. et al, 2016. *Residential Uses of Water 2016*. Water Research Foundation, Denver, CO.

⁷ DeOreo, W.B. and Mayer, P.W. et al, 1999, *Residential End Uses of Water*, AwwaRF, Denver, CO

⁸ NRDC. Pacific Institute. 2014. *Urban Water Conservation and Efficiency Potential in California*

5 CALIFORNIA WATER LAW

5.1 Basic concepts of water law in California:

- All water use must be **reasonable and beneficial**, and cannot be wasted.
 - Beneficial uses include irrigation.
 - Reasonable use varies as the current situation changes, e.g. drought.
- The water user does not own any water. Water rights are the legal entitlement to divert water from a specified source.
- Dual system of water rights
 - **Riparian rights** come with owning a parcel of land that is adjacent to a source of water.
 - **Appropriative rights** allow water to be diverted for use at a separate location. Forfeited if not used for 5-years. Entitlement to a specific amount of water with a date of priority.
 - Riparian rights have priority over appropriative rights; appropriative rights have priority according to date.



5.2 The **California Environmental Protection Agency (CalEPA)**⁹ is California's environmental authority and is responsible for developing, implementing, and enforcing environmental laws that regulate air, water and soil quality, pesticide use, and waste recycling and reduction. CalEPA consists of six agencies:

- The **State Water Resources Control Board (SWRCB)**¹⁰ has regulatory responsibility to protect water quality and allocate surface water rights.
- The **Department of Pesticide Regulation (DPR)** has the primary responsibility for regulating all aspects of pesticide sales and use to protect the public health and the environment.
- The other four agencies are the Air Resources Board (ARB), CalRecycle, the Department of Toxic Substances Control, and the Office of Environmental Health Hazard Assessment (OEHHA).



5.3 The **California Department of Water Resources (DWR)**¹¹ protects, conserves, develops, and manages much of California's water supply, including the State Water Project, which provides water for 25 million residents, farms, and businesses.

5.4 The **California Energy Commission (CEC)**¹² is the state's primary energy policy and planning agency, and is tasked by legislature to develop landscape irrigation efficiency standards.

⁹ <https://calepa.ca.gov/>.

¹⁰ <http://www.waterboards.ca.gov/>

¹¹ <http://www.water.ca.gov/>

¹² <http://www.energy.ca.gov/>

5.5 20x2020 (Figure 1-9)

- In 2009, California became the first state to adopt a water use efficiency target with the passage of SB X7-7, which mandated the State achieve a 20 percent reduction in urban per capita water use by 2020.

Figure 1-9: Conservation targets under 20x2020 compared with actual conservation

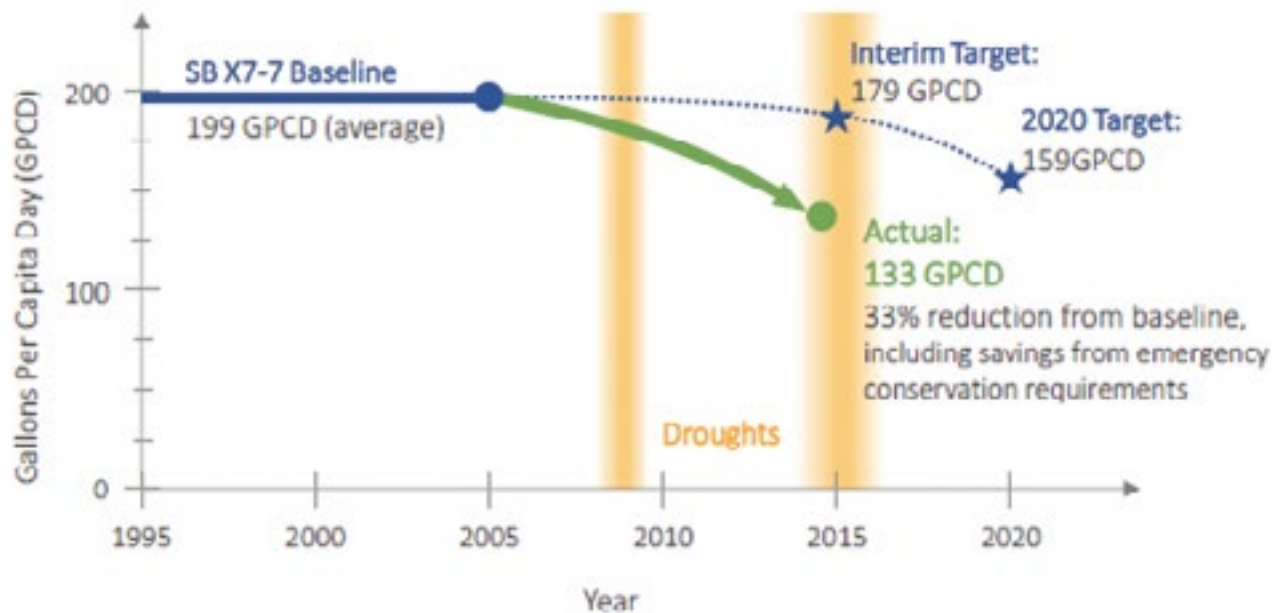

5.6 Making Water Conservation a California Way of Life¹³

- Following the 2014 – 2017 drought in California, five state agencies including the SWRCB and DWR issued a report detailing a long-term framework to make water conservation a California way of life with the objectives of using water more wisely, eliminating water waste, strengthening local drought resilience, and improving agricultural water use efficiency and drought planning.

5.7 Model Water Efficient Landscape Ordinance (MWELo)¹⁴

- Initially drafted in 1992 and updated in 2010 and in 2015, MWELo established a water budget for new construction and certain rehabilitated landscapes.
- MWELo will be updated every three years if needed, in line with the cycle for CALGreen.
- MWELo requires that landscape design, installation, and maintenance be water efficient.



5.8 CALGreen¹⁵, California's green building code, requires that new developments have indoor fixtures that meet specific efficiency requirements and landscapes that meet the requirements of MWELo.

¹³ http://www.water.ca.gov/wateruseefficiency/conservation/docs/20170407_EO_B-37-16_Final_Report.pdf

¹⁴ <http://www.water.ca.gov/wateruseefficiency/landscapeordinance/>

¹⁵ <http://www.bsc.ca.gov/Home/CALGreen.aspx>

6 NATIONAL AND STATEWIDE WATER USE EFFICIENCY PROGRAMS



- 6.1 The Environmental Protection Agency (EPA) [WaterSense](https://www.epa.gov/watersense)¹⁶ program is both a label for water-efficient products and a resource for saving water.
- WaterSense labeled products include irrigation controllers, toilets, showerheads, bathroom faucets, urinals, and pre-rinse spray valves.
 - WaterSense partners with manufacturers, retailers and distributors, homebuilders, irrigation professionals, and utilities to bring WaterSense to the community.



- 6.2 [Save Our Water](http://saveourwater.com/)¹⁷ is a statewide water conservation program in California that provides outreach and rebates to homeowners.

- 6.3 [LEED](https://new.usgbc.org/leed)¹⁸, or Leadership in Energy and Environmental Design, is a green building rating system.



- 6.4 The [Alliance for Water Efficiency](http://www.allianceforwaterefficiency.org/)¹⁹ (Alliance) is a stakeholder-based nonprofit organization dedicated to the efficient and sustainable use of water. The Alliance serves as a North American advocate for water efficient products and programs, and provides information and assistance on water conservation efforts.



- 6.5 The [California Water Efficiency Partnership](http://calwep.org/)²⁰ (formerly CUWCC) is an organization that provides leadership on water efficiency issues in California.



- 6.6 The [California Landscape Contractors Association](http://clca.org/)²¹ (CLCA) is a non-profit trade organization of licensed landscape and landscape-related contractors. The CLCA offers the Certified Water Manager and Landscape Industry Certified Technician programs.

- 6.7 There are many [public advocacy groups](#) throughout California that provide locally focused and statewide contributions to water use efficiency through research, publications, workshops, and education. The California Water Efficiency Partnership is a great way to connect with these organizations.

¹⁶ <https://www.epa.gov/watersense>

¹⁷ <http://saveourwater.com/>

¹⁸ <https://new.usgbc.org/leed>

¹⁹ <http://www.allianceforwaterefficiency.org/>

²⁰ <http://calwep.org/>

²¹ <http://clca.org/>

7 LOCAL UTILITY SPONSORED WATER USE EFFICIENCY PROGRAMS



7.1 The [Sonoma-Marín Saving Water Partnership](http://savingwaterpartnership.org/)²² represents 11 water utilities in Sonoma and Marin counties who have joined together to provide a regional approach to water use efficiency, including:

- Public outreach campaigns.
- Rebate programs.
- Eco-Friendly Garden Tour.
- Qualified Water Efficient Landscaper program.
- Water Smart Plant Label program.



7.2 [Russian River Friendly](http://www.rwatershed.org/)²³ and [Bay-Friendly](http://rescapeca.org/)²⁴ Landscaping is a whole systems approach to design, construction, and maintenance of landscapes. Best practices include:

- Landscape Locally.
- Landscape for Less to the Landfill.
- Nurture the Soil.
- Conserve Water.
- Conserve Energy.
- Protect Water and Air Quality.
- Conserve and Protect Wildlife Habitat.



7.3 The [UC Master Gardener Program of Sonoma County](http://ucanr.edu/sites/scmg/Garden_Sense_Master/Garden_Sense/) provides unbiased, high quality, science-based information to non-commercial home gardeners in Sonoma County. The [Garden Sense](http://ucanr.edu/sites/scmg/Garden_Sense_Master/Garden_Sense/)²⁵ program provides free consultations to Sonoma County residents on turf conversion, converting spray irrigation to drip, and low water use plants.



7.4 [Daily Acts](http://dailyacts.org/)²⁶ is a sustainability non-profit that works alongside local utilities to provide education and workshops on sustainable landscaping, rainwater harvesting, graywater, and more.



7.5 [Local utilities](http://www.savingwaterpartnership.org/partners/)²⁷ often provide incentives, technical assistance, and education to residential and commercial water customers (Table 1-1). Some utilities offer programs to agricultural customers. Check with your water supplier for the services that they offer.

- Residential programs are offered to single family and multi-family residential water customers.
- Commercial programs are offered to Commercial, Institutional, and Industrial (CII) water customers.

²² <http://savingwaterpartnership.org/>

²³ <http://www.rwatershed.org/>

²⁴ <http://rescapeca.org/>

²⁵ http://ucanr.edu/sites/scmg/Garden_Sense_Master/Garden_Sense/

²⁶ <http://dailyacts.org/>

²⁷ <http://www.savingwaterpartnership.org/partners/>

Table 1-1: Typical residential and commercial water use efficiency programs

Typical Residential Programs	Typical Commercial Programs
<ul style="list-style-type: none"> • Indoor and outdoor water smart check-ups • Water efficient fixtures • Rebates: <ul style="list-style-type: none"> - Turf conversion - Weather-based irrigation controllers - High-efficiency irrigation components - Soil moisture sensors - Rainwater harvesting - Graywater - Toilets - Clothes washers • Information and events: <ul style="list-style-type: none"> - Classes - Guides - Videos - Weekly watering schedules - Water smart plant fairs 	<ul style="list-style-type: none"> • Indoor and outdoor water smart check-ups • Water efficient fixtures • Rebates: <ul style="list-style-type: none"> - Turf conversion - Weather-based irrigation controllers - High-efficiency irrigation components - Soil moisture sensors - Rainwater harvesting - Graywater - Toilets - Urinals - Food equipment • Commercial and industrial high-efficiency equipment and process improvements • Potable water retrofit to recycled water • Professional training

8 WATER METERS

8.1 A water meter is a device that measures the **volume of water** used at a home or business.

- Water meters are usually installed, owned, and maintained by the water supplier.
- Depending on the utility, some meters are the property of the home or business owner and some are the property of the utility.

8.2 What does the law require for municipal water supply connections?

- **California:** State law has required that all homes built after 1992 have a water meter, and that homes built before 1992 must be retrofitted by 2025.
- **California:** MWELO requires that dedicated irrigation water meters be installed for residential landscapes of 5,000 sq. ft. or greater, and non-residential landscapes greater than 1,000 sq. ft. but not more than 5,000 sq. ft.

8.3 There are several categories of water meter commonly found:

- **Mixed-use meters** measure both indoor and outdoor water use and are found at the majority of residential properties.
- Dedicated irrigation meters measure only outdoor water use and are found at larger landscapes such as parks, HOA common areas, and sports fields.
 - A dedicated irrigation meter allows the accurate measurement and budgeting of landscape water.
- **Sub meters** are installed by businesses or homeowners to measure the water use of specific fixtures or certain types of water use.
 - Proper location and installation of a sub meter can facilitate measurement and budgeting of landscape water when there is not a dedicated irrigation meter.
 - Water providers do not read or maintain sub meters.

8.4 Reading a water meter is useful to:

- Understand how much water is being used in a specified time period, by a specific fixture, or by an irrigation hydrozone.
- Manage water use over time.
- Check for leaks.
- Provide utility billing based on water usage.

8.5 Water meters measure volume in **gallons** or **cubic feet** (CF). Water charges are typically based on 1,000 gallon or 100 cubic feet units. Table 1-2 identifies the billing units used by water suppliers in Sonoma and Marin counties.

- 1 CF = 7.48 gallons.
- 100 CF = 1 CCF = 748 gallons.

Table 1-2: Meter types in Sonoma and Marin counties

1,000 gallons	Hundred Cubic Feet
City of Cotati	City of Petaluma
City of Rohnert Park	Marin Municipal Water District
City of Santa Rosa	North Marin Water District
City of Sonoma	
Valley of the Moon Water District	
California American Water (100 gallon units)	
Town of Windsor (1 gallon units)	

8.6 There are three basic types of water meters:

- **Straight-reading meters** (Figure 1-10) are very common.
 - For a typical residential meter one sweep around the face is equal to 10 gallons or 1 cubic foot. For meters larger than 2-inches one sweep around the face is equal to 100 gallons or 10 cubic feet.
 - The black numbers with a white background reflect the current meter read either in 1,000 gallons or CCF.
 - Most have a low-flow indicator that turns as water moves through the meter. Typically a small triangle, star, or gear.
- **Digital-reading** meters are becoming more commonplace as older meters are replaced.
 - There will typically be a flashing indicator when water is moving through the meter.
 - The display may alternate between the meter read and the flow rate.
- Round-reading meters with several separate dials are less common.

Figure 1-10: Straight-reading meters in gallons (upper) and cubic feet (lower)



8.7 How to read a water meter

- Locate the water meter.
 - Generally located near the curb in front of the address in a concrete box with a concrete or cast iron lid marked water.
 - Carefully remove the lid using a meter key or large screwdriver.
 - Visually examine the area around the meter to make sure there are no harmful insects or other animals.
- Read and record the numbers on the face and/or take a photo.
 - In Figure 1-10 the meter on the left reads 3,699,389.3 gallons.
 - If the utility bills in units of 1,000 gallons they would read this meter as 3,699.



- Subtract the previous reading to determine water usage.
 - If the previous reading was 3,673 thousand gallons the usage would be 26 thousand gallons.

8.8 How to perform basic [leak detection](#).

- Ensure that [no water is currently being used](#).
 - Ensure that faucets and fixtures such as clothes washers and dishwashers are turned off.
 - Disable automatic fixtures such as ice machines.
 - Do not flush toilets.
 - Ensure that the irrigation system is not running.
- [Check the low flow indicator](#) on the water meter. Movement at the meter may indicate a leak.
- If the meter does not have a low flow indicator, mark the position of the sweep hand and/or record the numbers on the meter.
- Wait for a specified period of time, e.g. 30 minutes, and check the position of the sweep hand and/or take a second meter reading.
- To determine the size of a leak using a meter reading:
 - Subtract the first reading from the second to get the number of gallons or cubic feet.
 - Divide by the number of minutes to get the gallons or cubic feet per minute.
- [Tips for locating a leak](#):
 - If there is a shut-off valve to the house, close it and check the meter again.
 - If the meter has stopped moving the leak is probably indoors.
 - If the meter is still moving the leak is probably outdoors and/or the shut-off valve does not close properly.
 - If there is a shut-off valve to the irrigation system, close it and check the meter again.
 - If the meter has stopped moving the leak is probably outdoors in the irrigation system.
 - If the meter is still moving the leak is probably indoors and/or the shut-off valve does not close properly.
 - Toilets are a common source of indoor leaks. Check the water level inside the tank and then place vegetable dye tablets (or a few drops of food coloring) inside the tank. If the dye passes through to the toilet bowl in a few minutes, there is a leak.

8.9 Water meter [maintenance](#) is almost always the responsibility of the retail water supplier.

- [Do not operate the shut-off valves](#) on either side of the meter.
 - The water account holder will be liable for the cost of any repair.
- Contact the water supplier for any maintenance issues such as a leak, a strange noise, or an incorrect meter reading.

9 WHERE OUR WATER COMES FROM REVIEW QUESTIONS

- 9.1 Explain the concept of the water cycle.
- 9.2 What is a watershed?
- 9.3 Can a residential lot be viewed as a small watershed?
- 9.4 True or false: California's climate is highly variable and is prone to cyclical periods of drought.
- 9.5 True or false: California has built a water system to move water around the state.
- 9.6 What is the name of the primary river in Sonoma County?
- 9.7 Name the two major water reservoirs serving Sonoma and parts of Marin County.
- 9.8 What are the names of the three threatened or endangered fish species in the Russian River and its major tributaries?
- 9.9 Name four sources of water utilized by retail water agencies.
- 9.10 True or false: The majority of water supplied by Marin Municipal Water District is surface water?
- 9.11 What are the primary uses of water in the average household?
- 9.12 Name the two California state agencies responsible for the regulation and management of California's water supply.
- 9.13 True or false: The MWELO and CALGreen are regulations that ensure that new homes and landscapes are water efficient?
- 9.14 True or false: EPA WaterSense, Save Our Water, and LEED are national or statewide water efficiency programs.
- 9.15 Who should you check with for information about local water use efficiency programs?
- 9.16 What is a water meter?
- 9.17 What are some reasons to read a water meter?
- 9.18 What are the two units of measurement used by different water meters?
- 9.19 What are the two billing units used by retail water agencies?
- 9.20 What's the easiest way to check for a leak?

Section 2:
**SUSTAINABLE
LANDSCAPING**





SUSTAINABLE LANDSCAPING

Learning Objectives

1. Be familiar with the concept of sustainable landscaping
2. Understand the reasons for adopting sustainable landscaping
3. Understand key sustainable landscaping practices

1 SUSTAINABLE LANDSCAPING CONCEPT

- 1.1 Sustainable landscaping is an approach to landscape design, construction, and maintenance that encompasses ecologically sound practices. One way to look at sustainable landscapes is as [mini-watersheds](#) that retain and clean storm water, conserve resources, and provide a healthy habitat for plants and wildlife.
- 1.2 Sustainable landscaping is a whole systems approach.
 - The focus of the QWEL program is on practicing [efficient irrigation](#) and [water management](#).
 - These practices are key components of the landscape system and are enhanced by the use of other sustainable landscaping practices.

2 WHY SUSTAINABLE LANDSCAPING?

- 2.1 Sustainable landscapes are increasingly [required by regulation](#) such as MWEL in California.
- 2.2 The installation and maintenance of sustainable landscapes provides landscape professionals with the [opportunity to generate revenue](#) by offering landscape conversion services, water management, and maintenance requiring specific skills and expertise.
 - Sustainable landscape maintenance includes hand pruning, soil management, and water management. Additional knowledge and skills are required to maintain plant health as well as the function of green infrastructure such as rain gardens and swales.
- 2.3 Sustainable landscapes are an [aesthetic and functional upgrade](#) to outdated traditional landscapes.
 - Property owners are increasingly converting traditional landscapes to sustainable landscapes, and their neighbors are starting to take notice.
- 2.4 Sustainable landscapes [save water, time, and money](#).
 - The City of Santa Monica garden\garden project (Figure 2-1) provides a side-by-side comparison of a sustainable landscape with a traditional landscape. The City of Santa Monica collected data on the amount of water used, green waste generated, and maintenance hours for both gardens.
 - The project demonstrates that a sustainable landscape needs significantly less water than a traditional landscape, produces less green waste, and requires significantly fewer maintenance hours.
- 2.5 Healthy living soils enable plants to thrive, hold more water, and are able to absorb water more quickly.
- 2.6 Selecting climate appropriate plants helps to ensure that they will thrive in the landscape which reduces the ongoing costs associated with plant replacement.
- 2.7 By keeping storm water and graywater onsite, sustainable landscapes provide cleaner waterways and oceans, protect wildlife habitat, and contribute to groundwater recharge.
- 2.8 Diverse landscapes provide food and shelter to wildlife.
- 2.9 By providing shade to urban environments whilst reducing the use of synthetic fertilizers and gas powered maintenance equipment, sustainable landscapes reduce energy consumption and contribute to cleaner air.

Figure 2-1: City of Santa Monica garden\garden project (<http://www.sustainablesm.org/gardengarden>)

The City of Santa Monica garden\garden project compared sustainable and traditional landscape practices of two adjacent properties in Santa Monica from 2004 to 2013. The project demonstrates the dramatic savings in water, green waste, and maintenance that can be achieved with a sustainable landscape.

Traditional Landscape

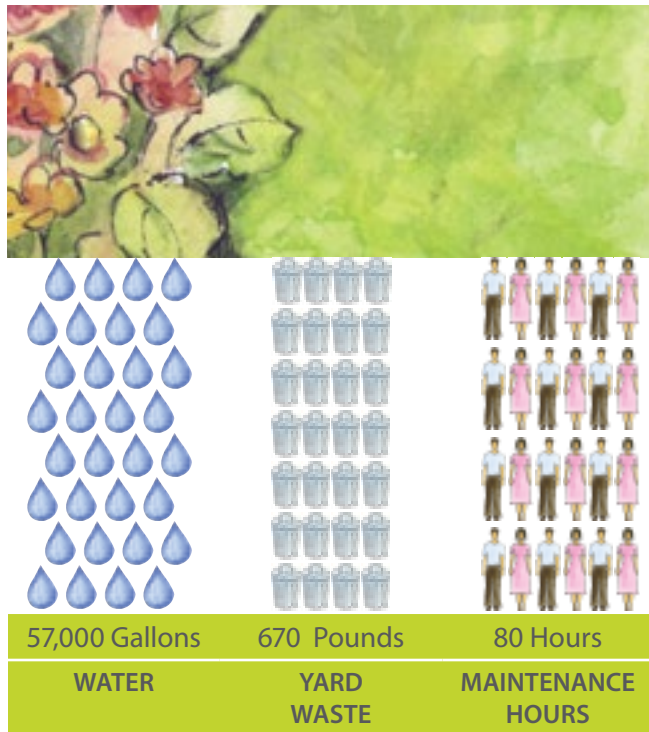

Sustainable Landscape

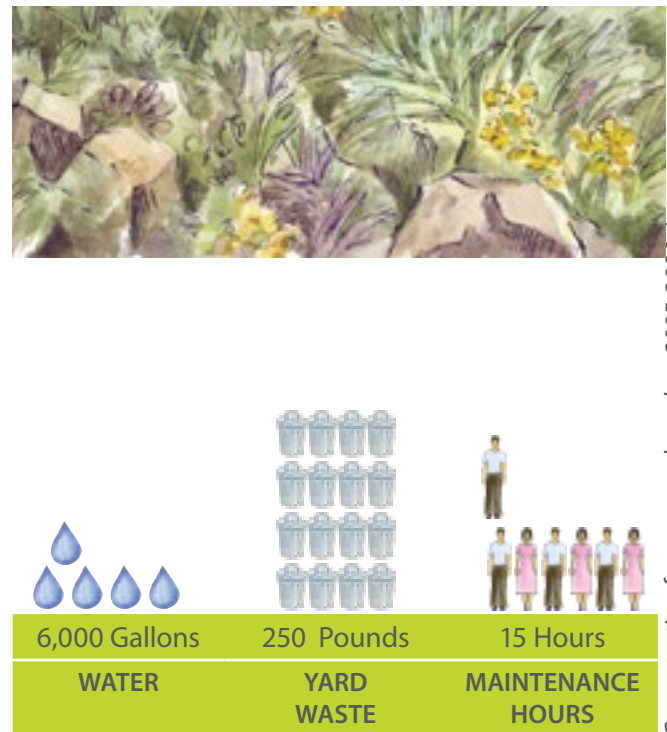

Consumption for one year based on 2005-2006 data.

Figure 2-2: San Diego Sustainable Landscaping Guidelines (<http://sustainablelandscapesd.org/>)

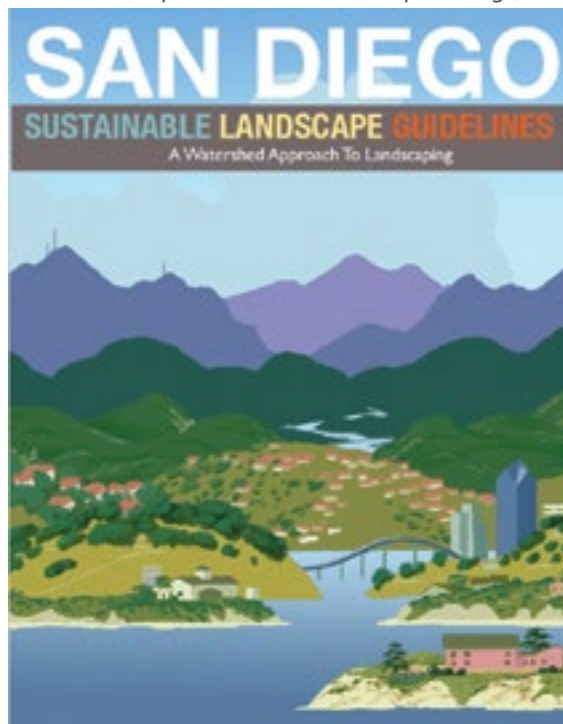

Figure 2-3: Sustainable landscaping practices



3 SUSTAINABLE LANDSCAPING PRACTICES OVERVIEW

3.1 **Landscape locally** – landscapes should be considered mini-watersheds that reside within a larger watershed (Figure 2-4).

- Sustainable landscaping begins with a site assessment including the soil, topography, existing plants, and microclimates.
- It is important to understand the sources of water, how water flows, and how water is used:
 - Building roofs are often located at the top of the mini-watershed and provide a source of water during rain events.
 - Water travels downhill due to gravity, it runs off impermeable surfaces, and infiltrates into permeable surfaces.
 - Water that runs off the landscape typically flows into storm drains, which connect to creeks and rivers. Some locations have combined sewer systems where rainwater runoff and sewage are transported to a sewage treatment plant.
 - In some communities, residents and users of building structures can provide an additional supply of water in the form of graywater that can be diverted into the landscape.
 - Soil type and structure provide information about how quickly water can be absorbed into the soil and how much water can be stored in the soil.
- An understanding of existing plants on the site and local plant communities helps to provide a sense of place and is a great starting point for selecting appropriate plants for a landscape.
 - The plants selected for a landscape determine how much water is needed.

3.2 **Foster healthy living soils** (Figure 2-5) – soil is a combination of minerals, air, water, organic matter, and microorganisms and is the foundation of a sustainable landscape.

- Healthy living soil is teeming with bacteria, fungi, protozoa, beneficial nematodes, insects, worms, and other organisms.
- **Section 3** provides a detailed overview of soils including mulch and soil amendments. Below are a few key sustainable landscaping practices that relate to soils.
- **Organic matter** is a vital component of living soils. It includes plant and animal debris in various stages of decay as well as many living organisms. Incorporating organic matter improves soil health, productivity, water retention capacity, and carbon sequestration.
 - Recycling organic matter onsite reduces the need for supplemental fertilizer application.
 - Adding compost and other organic soil amendments kick-starts neglected or non-living soils.
 - Retaining leaf litter and plant clippings onsite to improve soil structure and recycle nutrients. They can either be left in place or composted and reapplied to the soil surface.
 - Avoiding tilling to protect soil structure.
- **Mulch** applied to the surface of the soil limits water lost to evaporation, moderates soil temperature, and reduces weed seed germination.
 - A **2 to 4-inch** layer of **organic mulch** is recommended, depending on the material used.
 - Keep mulch away from the crown of the plants and tree trunks.
 - Some areas of bare soil are recommended to provide habitat for beneficial insects.
 - Living green mulch can also be used to cover areas of bare soil, and involves planting desirable low growing plants as an understory to other landscape plantings.
 - Organic mulch is an effective alternative to landscape fabric and plastic sheeting. Organic mulch

Figure 2-4: A traditional landscape (upper) compared to a sustainable landscape (lower)

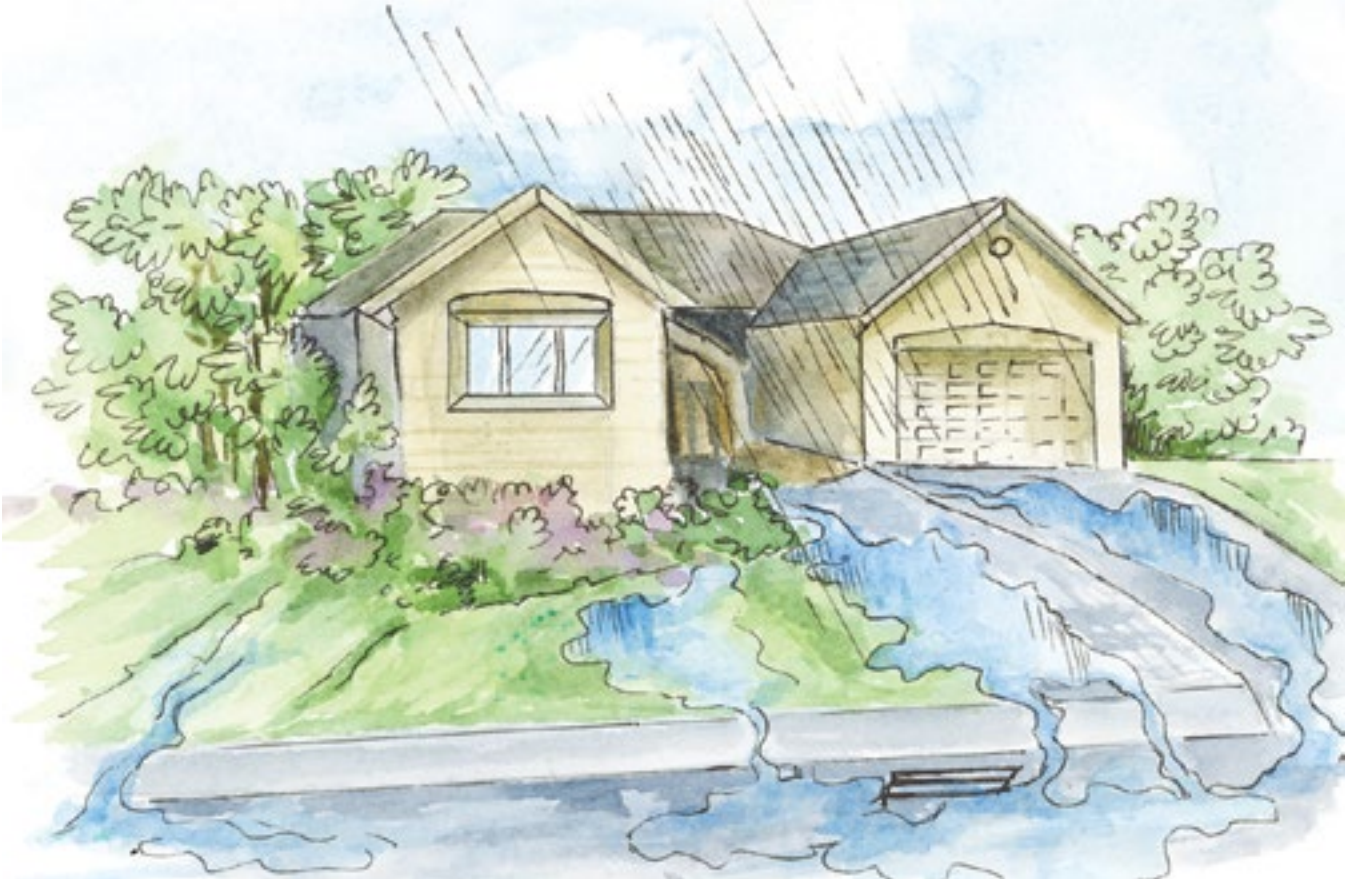

improves soil health over time, whereas landscape fabric and plastic sheeting eventually break down leaving small pieces of plastic in the landscape that may be harmful to wildlife.

- **Reducing or eliminating pesticides and herbicides** limits human and wildlife exposure to harmful chemicals, and reduces landscape input costs.
- **Preventing soil compaction** and de-compacting damaged soils allows subsurface air and water flow, plant growth, and water storage.
- **Sheet mulching** (Figure 2-6) is a quick and inexpensive approach to turf conversion that provides an environmentally friendly alternative to removing turf while simultaneously improving the soil.
 - Sheet mulching involves composting existing turf in place.
 - Rather than cutting the turf out or killing it with herbicide, it is smothered with layers of cardboard, compost, and organic mulch.
 - As the turf and other materials decompose they return nutrients to the soil and benefit the soil food web.

Figure 2-5: Soil food web

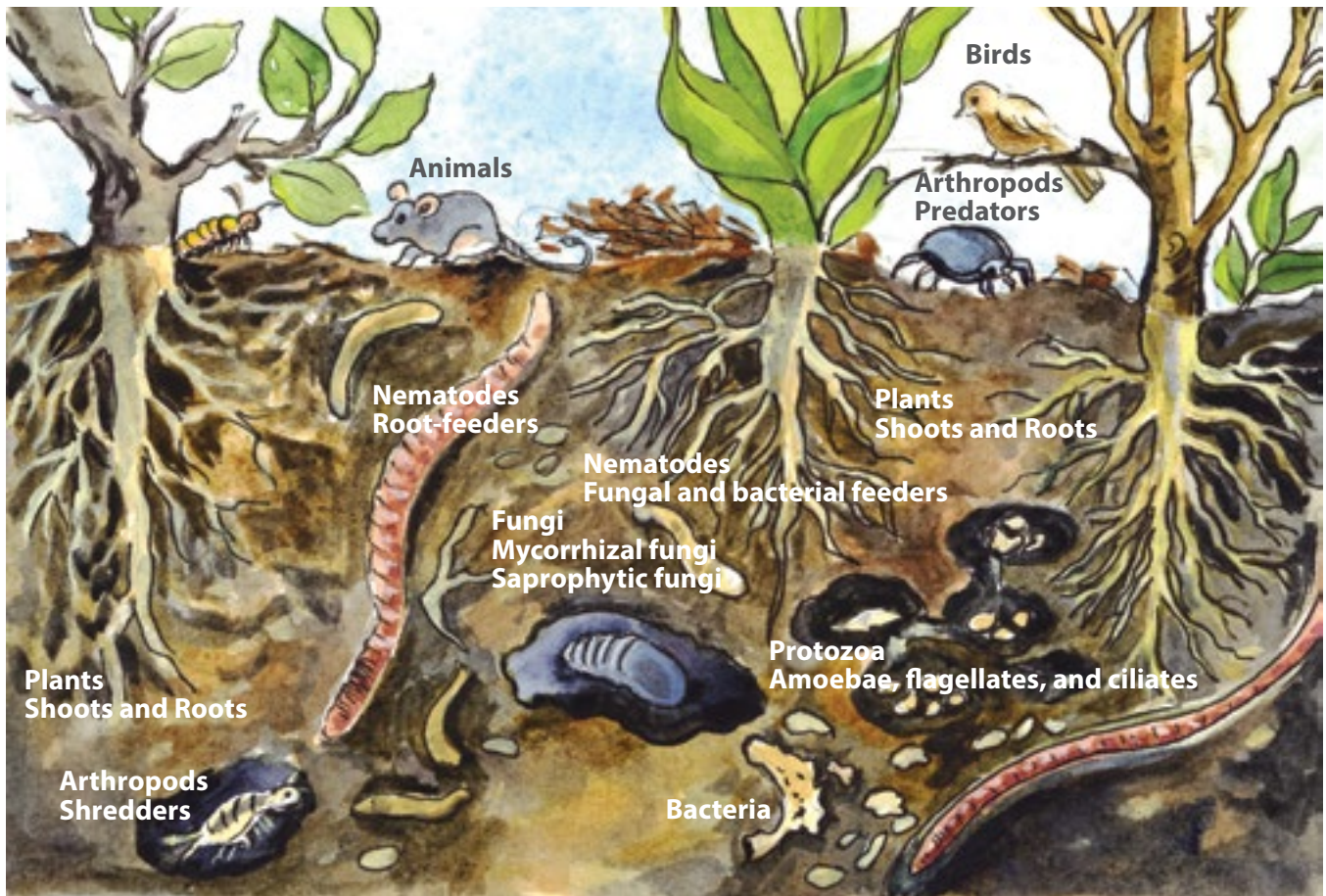

Compost & Mulch Volume Calculation:

Area in square feet x Depth in feet = Volume in cubic feet

Volume in cubic feet ÷ 27 = Volume in cubic yards

Example: How many yards of mulch are needed to cover a 1,000 sq. ft. area with 3 inches of mulch?

$1,000 \times (3 \div 12) = 250$ cubic feet

$250 \div 27 = 9.26$ cubic yards

Figure 2-6: Sheet mulching

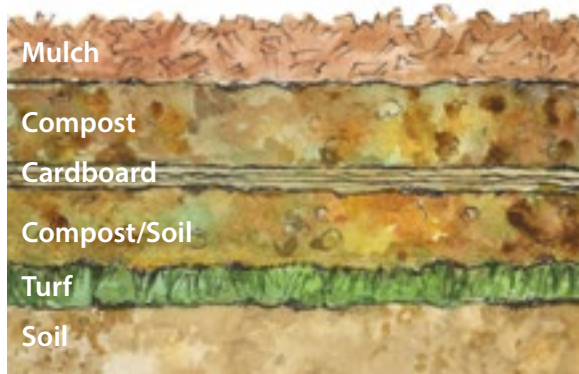

Type of Turfgrass

- Sheet mulching is most effective for removing cool season grasses.
- Warm season grasses such as Bermudagrass and St Augustine tend to come back aggressively and will require additional intervention over time.
- One alternative is to use a sod cutter to remove warm season grasses and as much of the roots as possible before sheet mulching to improve soil structure.
- Be careful not to till areas with species that can grow from root fragments (Bermudagrass) or bulbs (oxalis and yellow nutsedge) as this will result in them spreading and proliferating.

Sheet mulching process

- Remove or cap any sprinkler heads or convert the sprinkler system to drip.
- Remove any invasive species.
- Mow the lawn and leave the grass clippings in place.
- Bevel all edges that contact hardscape.
- Contour the area to optimize rainwater capture.
- Water the area thoroughly.
- Plants in 5 gallon or larger containers can be planted before the sheet mulching is applied leaving the rootball extending 3-4 inches above the soil surface.
- Lay cardboard or similar organic weed barrier over area.
- Overlap edges by 6 - 8 inches to block out light.
- Thoroughly wet the cardboard to keep it in place and to kick start the composting process.
- U stakes can also be used to secure cardboard.
- If waiting to plant add 2 to 4 inches of compost followed by 2 to 4 inches of mulch.
- If planting immediately add 3 to 4 inches of soil, then install plants from 4-inch pots, install drip irrigation, and finish with 2 to 4 inches of mulch.
- Water thoroughly after each layer is applied, or wait for the rain to come.
- For best results wait a few months for the process of decomposition to get a head start before planting.
- Consider the suitability of the materials being used for the plants that will be installed.

3.3 **Right Plant, Right Place, Right Time** – appropriate plant and landscape materials determine how much water and long term maintenance the landscape needs.

- **Section 4** provides an overview of **plant water use** and the concept of a **hydrozone**. Below are some additional sustainable landscaping practices that relate to plants.
- Choose **native**¹ or climate-adapted plants for a specific region and geography (Figure 2-7).
 - Many native plants provide essential habitat for pollinators, insects, birds, and other animals.
 - Native plants are adapted to our local climates, often require less water during the summer months, and produce less green waste than a traditional landscape when managed and irrigated properly.
- Choose **non-invasive** plants that won't spread aggressively and cause ecological damage. The USDA publishes a list of introduced invasive and noxious plants².
 - Within California the **California Invasive Plant Council**³ and **Plant Right**⁴ provide lists of plants to avoid.
- Areas of turfgrass provide great recreational spaces but should be **limited to planned functional areas** in shapes that can be irrigated efficiently and without overspray and run off.
- Where turfgrass is being installed:
 - Consider drought tolerant and no mow varieties. Warm season varieties require significantly less water than cool season varieties and tend to be more tolerant of drought conditions.
 - Use maintenance practices such as an increased mowing height and limited watering to encourage deeper root system development, improve drought tolerance, and reduce inputs⁵.

Figure 2-7: California native plants clockwise (1) *Ceanothus*, (2) *Chalk Dudleya*, (3) *White Sage*, (4) *Coast Live Oak*



1. *Ceanothus*



2. *Chalk Dudleya*



4. *Coast Live Oak*



3. *White Sage*

¹ <http://calscape.org/>

² <https://plants.usda.gov/java/noxiousDriver>

³ <http://cal-ipc.org/>

⁴ <http://www.plantright.org/>

⁵ <http://ucanr.edu/sites/UrbanHort/files/218577.pdf>

- Consider planting edible plants in a portion of the landscape.
- Select and space plants for **mature size** to avoid the need for excessive pruning. This reduces the amount of maintenance required and promotes healthier plants.
- Select plants that are suited to the existing soil type and pH so that they can efficiently obtain nutrients without supplemental fertilizers.
- Plant in the appropriate seasons to help conserve water. The middle of **fall** is typically the best time to plant in California when the intensity and duration of solar radiation is lower; and winter rains help to establish the root systems of new plantings.
- Applying only the amount of water required in established landscapes can reduce **excessive plant growth** and vigor, which results in less maintenance and green waste.
 - Over- or under-irrigating is a major cause of plant failure. Plants from Mediterranean, desert, and steppe climates are often susceptible to disease with too much water.
 - Drowning is a major cause of plant failure because healthy soils and roots need oxygen.
 - Heat and cold stress plants. Properly hydrated plants have a greater ability to withstand such stresses.
- Prune to enhance a plant's natural shape and structural strength, remove weak or diseased stems/branches, improve yield of flowers and fruit, and to maintain design intent.
 - Avoid pruning into geometric shapes.
- Have an understanding of the plants in the landscape and their regular management and maintenance requirements (Figure 2-8).
- Remove weeds that compete with landscape plants for water and nutrients.
- Recycle plant debris onsite by composting, grass cycling, and chipping.
- Proper soil management should mean that most landscapes don't require supplemental fertilizer application. However, if adding fertilizer, favor slow release organic fertilizers and avoid synthetic, quick release fertilizers.
- Use **integrated pest management**⁶ (IPM) to manage pests. IPM focuses on prevention of pests or their damage through a combination of all techniques such as biological control, habitat manipulation, modification of cultural practices, and use of resistant varieties.
 - Chemical controls such as **pesticides are used as a last resort** in IPM.
- Use **firescaping** to create defensible space around homes and properties against fire (Figure 2-9).

Figure 2-8: California Friendly Maintenance Guide (www.bewaterwise.com/GMG.shtml)

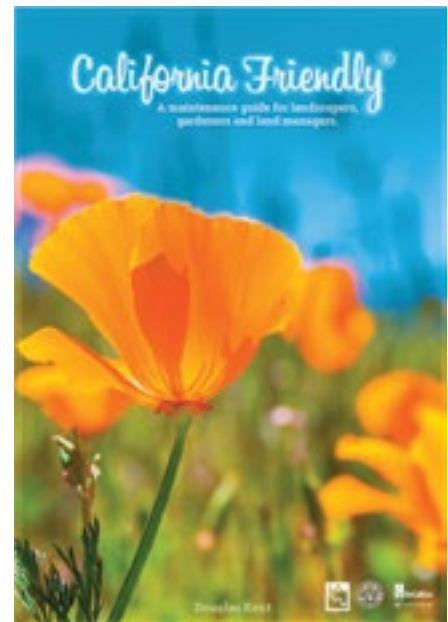

Figure 2-9: Wildfire defensible space (Image courtesy of Cal Fire www.readyforwildfire.org)



⁶ <http://ipm.ucanr.edu/>

3.4 **Conserve water** – Section 1 provided insight into where our water comes from and how water is used and highlights the importance of conserving water.

- Water conservation in a sustainable landscape begins with healthy living soil to **maximize water holding capacity**, and a climate appropriate plant selection to **minimize how much supplemental water is needed**.
- **High-efficiency** irrigation systems and **landscape water management** are important components of conserving water supplies and are covered in detail in the following sections.
- Use the **water meter** as a tool for managing landscape water use where possible.
- A dedicated irrigation meter is recommended for large and non-residential landscapes.
- Capture and retain **rainwater** to limit the need for supplemental irrigation, and reduce storm water runoff.
 - Downspouts can be redirected to **rain gardens** (Figure 2-10) to retain storm water onsite and recharge groundwater.
 - Downspouts can also be redirected into **rain barrels or cisterns** to store water for future use.
 - Water stored in rain barrels can be released following each rain event. This strategy helps to **reduce peak flows** into storm drains and recharge groundwater.
 - For mosquito abatement, ensure that storage containers are properly sealed and that infiltration systems such as rain gardens are designed to drain within 48 to 72-hours.
 - In climates with freezing temperatures, rainwater harvesting systems require additional precautions to prevent damage from freezing.
- Where legally allowed, reuse **graywater** to limit the need for supplemental irrigation, and reduce wastewater flow.
 - Graywater is wastewater generated from domestic activities such as laundry and bathing, which can be reused onsite for uses such as landscape irrigation.
 - Reusing graywater can provide significant potable water savings and reduces flows to the wastewater treatment plant.
 - More information relating to graywater systems is available in the **QWEL Graywater Specialty Module**.
- The use of alternate water sources such as graywater and rainwater is regulated by **state and local laws**. Check local codes and regulations for additional requirements.

Rainwater Volume:

- 1 inch of rain falling on a 1,000 square foot roof will generate approximately 600 gallons of runoff
- Rain catchment potential = area in square feet x rainfall in inches x 0.62

Graywater sources include:

- Clothes washers
 - 8,000 gallons per household per year
- Showers and baths
 - 11,000 gallons per household per year
- Bathroom sinks

Graywater sources do not include:

- Toilets
- Kitchen sinks or dishwashers
- Clothes washers when washing diapers, greasy rags, or loads containing other chemicals

Figure 2-10: Rain garden



3.5 **Protect water and air quality** – as part of a larger watershed, each landscape has an impact on the environment. Sustainable landscapes can be designed to reduce the amount of pollution that runs off into streams and creeks.

- When rain falls in the natural environment, most of it soaks into the ground. But when rain falls on impervious surfaces such as pavement and rooftops it runs off and can wash pollutants into the storm drain system, which connects to our creeks and rivers.
- **Runoff** from roofs and other impervious surfaces can result in a number of undesirable consequences such as increased peak flows in creeks, pollution, erosion, degraded fish and wildlife habitat, and damage to surfaces and structures.
- Practices⁷ to minimize the effects of storm water include:
 - **Slow** the runoff.
 - **Store** it for the future.
 - **Spread** it out in planters, gardens, and other permeable surfaces.
 - **Sink** it back into the ground.
- **Green infrastructure** is a cost-effective approach to contain and treat stormwater at its source. Runoff is directed into features where it can soak into the ground. This approach mimics the storm water benefits of the natural environment. Specialized swales, planters, and raingardens provide beauty while also slowing runoff and removing pollutants. Plants and microbes that live in healthy soil use pollutants as nutrients, removing them from runoff.
- **Use permeable landscape materials** to clean and absorb water, recharge groundwater, and limit the need for supplemental irrigation.
 - Permeable “hardscape” surfaces include sand set pavers and flagstones, interlocking pavers, gravel, and permeable concrete.
- Air quality can be improved by reducing the use of power equipment.
- Plants contribute to cleaner air as they absorb air through their leaves and roots.
- Properly composting plant debris reduces harmful green house gas emissions such as methane.

3.6 **Create and protect wildlife habitat** – landscapes provide essential habitat for wildlife in urban environments (Figure 2-11).

- Recognize that in many urban areas, landscapes are the ecosystem. Therefore, plant and other landscape choices have an impact on wildlife species.
- Wildlife need food, water, cover, and space.
 - Examples of wildlife in the landscape include insects, birds, butterflies, bees, mammals, and soil fauna such as worms, bacteria, fungi, protozoa, and nematodes.
- A diverse landscape provides the most wildlife benefit:
 - Local native plants typically offer the most habitat value to local native wildlife species.
 - Incorporate a variety of deciduous and evergreen plants for aesthetic and structural diversity.
 - Select plants that utilize vertical space by including plants of different heights such as trees, shrubs, and groundcovers.
 - Select plants that bloom and fruit at different times of year.
 - Recognize that large areas of turf do not provide significant wildlife habitat value.

⁷ <https://sonomarcd.org/documents/Slow-it-Spread-it-Sink-it-Store-it.pdf>

Figure 2-11: Habitat gardening (image courtesy of the City of Santa Rosa)



- When using landscapes to create and protect wildlife habitat together with IPM, some damage to or loss of plant material should be expected.

3.7 Conserve energy – sustainable landscapes use less energy than traditional landscapes.

- Potable water use has **embedded energy** associated with it due to the energy consumed to collect, treat, transport, and distribute it from the source to the end user. Using less potable water saves energy.
- Sustainable landscapes can **shade** our buildings and other hardscapes to moderate temperatures. This can reduce summer cooling costs in buildings and mitigate the heat island effect of parking lots and streets.
- Gas powered landscape maintenance equipment such as vehicles, lawn mowers, and leaf blowers use significant amounts of fuel which generates pollution.
 - Minimize the need for extensive use of maintenance equipment by selecting the right plant, right place, right time.
 - Use hand powered equipment where possible.
 - Minimize the use of gas powered leaf blowers.
 - Minimize hauling by recycling plant debris on site using grasscycling, composting, and chipping.
- Consider the useful life and embodied energy of the materials used such as plants, stone, gravel, and lumber.
 - Source materials as locally as possible to reduce green house gas emissions from transportation.
 - Smaller plants in 4-inch pots are cheaper to transport, easier to install, transplant effectively into native soils. Many plants transplanted from small pots grow rapidly to mature size.

4 SUSTAINABLE LANDSCAPING REVIEW QUESTIONS

- 4.1 What is sustainable landscaping?
- 4.2 Name the seven sustainable landscaping practices outlined.
- 4.3 What does it mean to consider a landscape site as a mini-watershed?
- 4.4 True or false: organic matter is an essential component of living soil?
- 4.5 Explain the process of sheet mulching, when it might be used, and why.
- 4.6 Why is it important to plant native or climate appropriate plants?
- 4.7 Suggest a practice to reduce excessive plant growth and green waste.
- 4.8 True or false: Drowning is a major cause of plant failure.
- 4.9 Using integrated pest management (IPM), when would pesticides be used?
- 4.10 Name two alternatives to potable water for use in the landscape.
- 4.11 Approximately how much runoff will 1 inch of rain on a 1,000 sq ft roof generate?
- 4.12 Name some common sources of graywater.
- 4.13 What is low impact development?
- 4.14 Name some of the benefits to sustainable landscaping.

Section 3:
SOILS





SOILS

Learning Objectives

1. Be familiar with different soil properties
2. Know how to recognize or identify different types of soil
3. Understand how water interacts with various soil types
4. Know how to monitor soil moisture
5. Have an understanding of common soil issues
6. Know the role of mulches and soil amendments

1 SOIL PROPERTIES

1.1 Soil is unconsolidated mineral or organic material on the surface of the Earth that serves as a natural medium for the growth and anchoring of plants. Soil properties contribute to:

- The rate at which [water penetrates](#) into the soil.
- The rate at which [water is lost](#) by evaporation.
- The ability of the soil particles to [hold water](#).

1.2 Four major components of soil:

- Air
- Water
- Organic matter
- Mineral matter
 - Sand
 - Silt
 - Clay
- Proportions vary for different soils but a good soil for growing plants should generally contain about [50% pore space](#) and [50% solids](#). The pore space should consist of half air and half water, and the solids should be made up mostly of minerals mixed with some organic matter (Figure 3-1).

Figure 3-1: Major components of soil

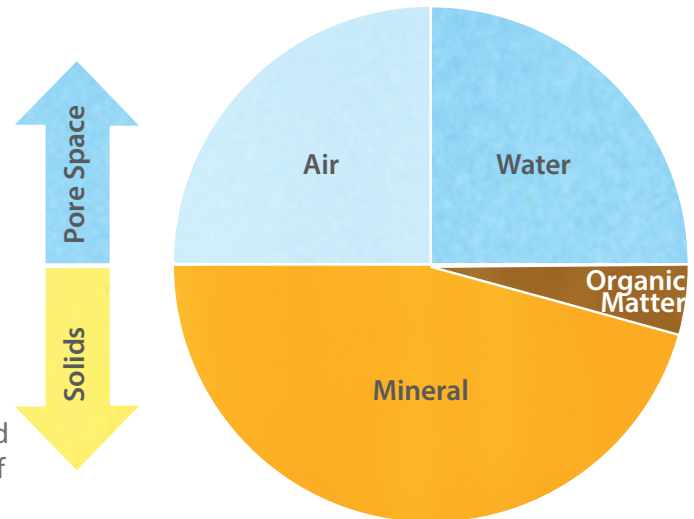

- Soil organic matter is beneficial to all types of soils either to retain water or increase air space, both of which are beneficial for plant health.

1.3 Soil functions are often challenged in urban settings due to issues such as compaction. Healthy soil is essential for cleaning and storing storm water, and for maintaining plant health. Vital functions of soils include:

- Sustaining plant and animal life above and below the surface (Figure 3-2).
- Medium for water and nutrient flow.
- Filtering, buffering, degrading, immobilizing, and detoxifying.
- Storing and cycling nutrients (Figure 3-3).
- Providing support to plant and man-made structures.

1.4 It is important to understand [how water and soils interact](#) in order to properly apply the correct amount of irrigation water at the appropriate rate and at the right time.

- Water moves relatively quickly through [sandy soils](#) but they have a lower water holding capacity.
 - Irrigation strategy: shorter run times to prevent water draining beyond the root zone, more frequent water days due to lower water holding capacity.
- Water moves relatively slowly through [clay soils](#) but they have a higher water holding capacity.
 - Irrigation strategy: lower application rate to prevent runoff, multiple start times to give water time to move through the root zone and allow time for air to return to the soil, less frequent water days due to higher water holding capacity.

Figure 3-2: Soil food web

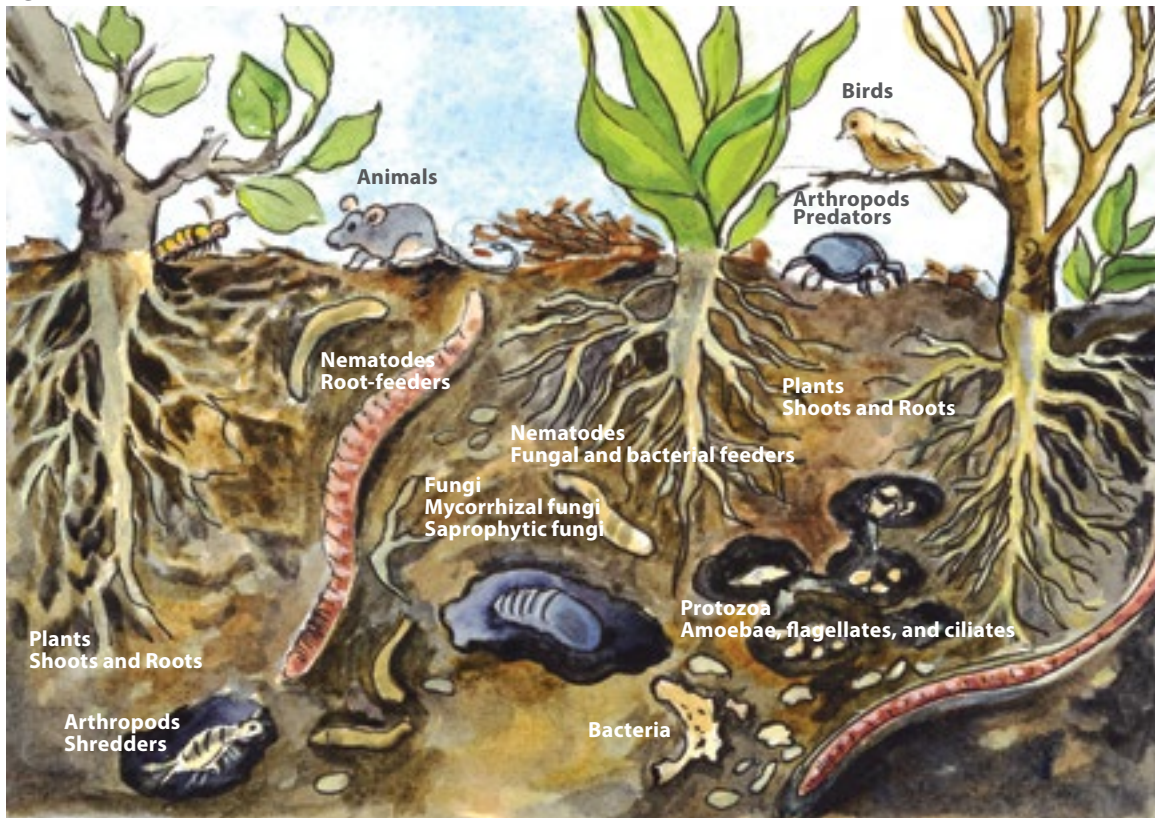
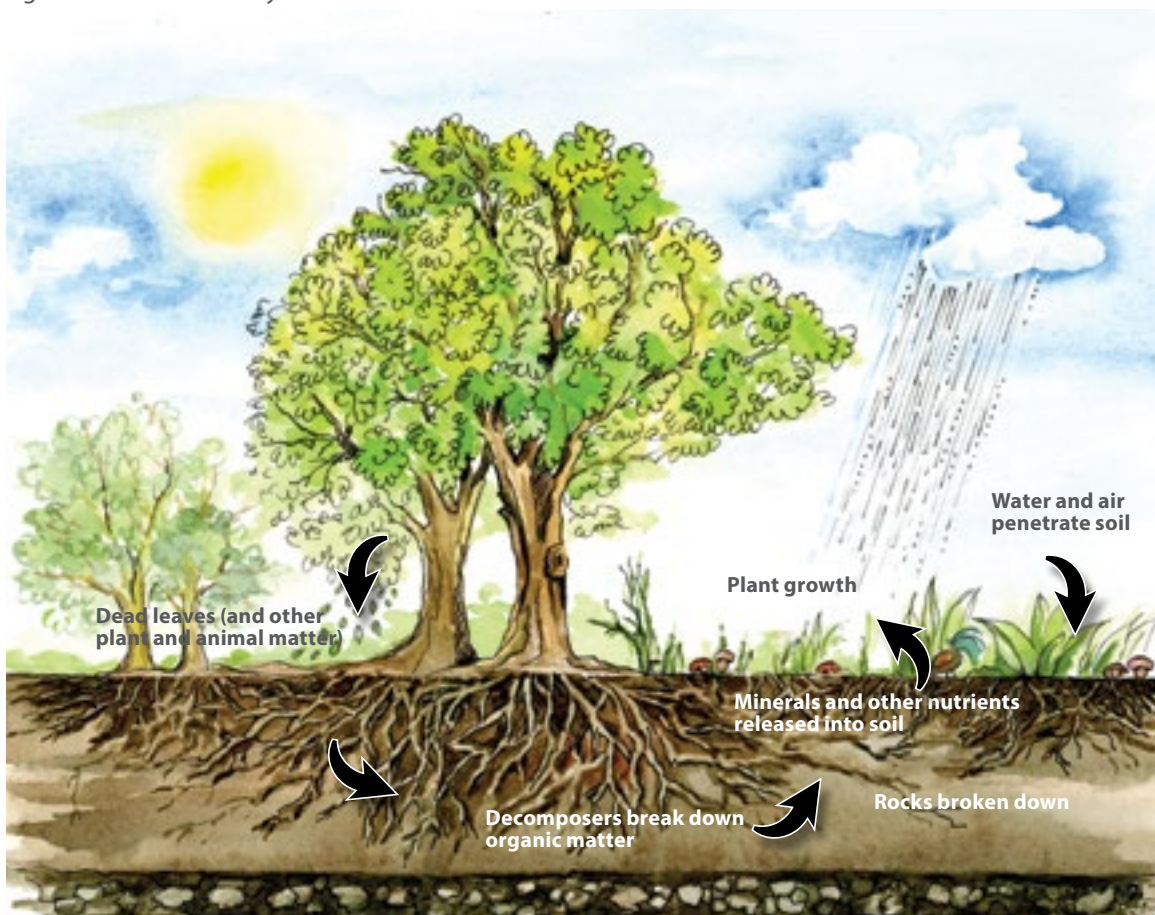

Figure 3-3: Soil nutrient cycle



2 SOIL TYPES

2.1 **Texture** refers to the mineral content of soil and is determined by the proportions of sand, silt, and clay known as **soil separates** (Figure 3-4). The three soil separates vary in size, chemical properties, and physical properties.

- **Sand**
 - The largest particles are mostly weathered quartz.
 - Size varies between 2.0 and 0.05 mm in diameter.
- **Silt**
 - Larger than clay and smaller than sand.
 - Size varies between 0.05 and 0.002 mm in diameter.
- **Clay** (invisible at this scale)
 - The smallest soil mineral constituent.
 - Size is less than 0.002 mm in diameter.

Figure 3-4: Relative size of soil separates

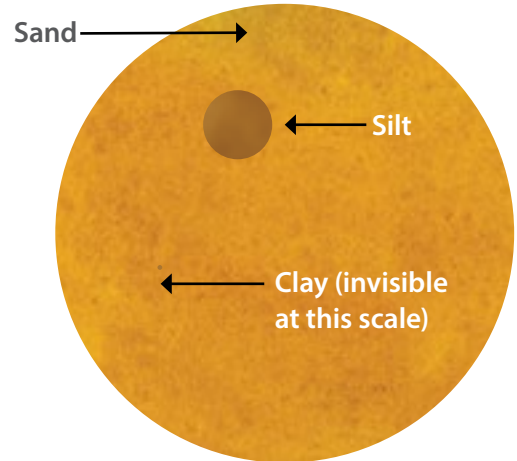

2.2 **Soil texture cannot be changed.**

2.3 There are **12 textural classes** of soil based on the percent of sand, silt, and clay that a soil sample contains. The soil textural triangle can be used to identify the textural class if the **percent of each soil separate** is known.

2.4 Steps for using textural triangle (Figure 3-5):

- Identify the percentage of **sand** separate along the **bottom** of the triangle and draw a line up that is parallel to the right side of the triangle (1).
- Identify the percentage of **silt** separate along the **right** side of the triangle and draw a line down that is parallel to the left side of the triangle (2).
- Identify the percent of **clay** separate along the left **side** of the triangle and draw a line across parallel to the bottom of the triangle (3).
- The point at which the three lines intersect is the soils textural class.

2.5 Example textural classes:

Table 3-1: Example soil textural classes

Percent Sand	Percent Silt	Percent Clay	Textural Class
40	40	20	Loam
30	35	35	Clay loam
60	30	10	Sandy loam

Figure 3-5: Soil textural triangle (image courtesy of United States Department of Agriculture)

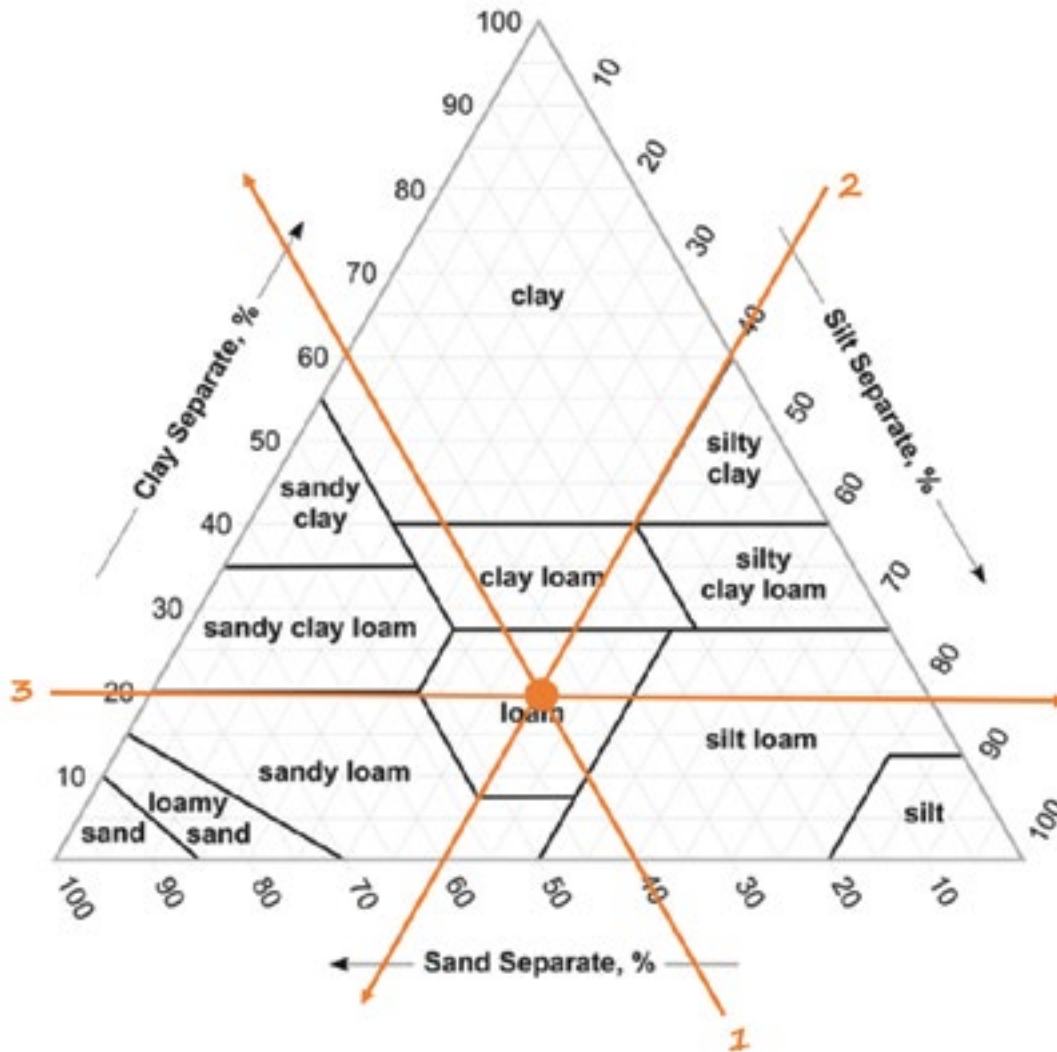

2.6 Soil Testing

- A soil test with a [professional laboratory](#) will accurately identify soil texture and provide information such as organic matter content, pH, salinity, and nutrient levels.
- When preparing a soil sample, [follow the directions of the laboratory](#).
- General directions for taking a soil sample:
 - Depending on the size of the area being tested, take 5 – 20 random samples.
 - Samples should be to a depth of 12-inches.
 - A soil probe is the ideal tool for this, or a spade is a good alternative.
 - Ensure tools used are clean.
 - Scrape away surface residue.
 - Mix the samples together and take a subsample to send to the laboratory.
 - A re-sealable plastic bag is the ideal container for a soil sample.
 - About 2 cups of soil is normally sufficient for testing.
- Lists of soil testing laboratories are often published by local universities and cooperative extension services.

Figure 3-6: Soil analysis report example (image courtesy of A & L Western Agricultural Laboratories)



A & L WESTERN AGRICULTURAL LABORATORIES

1311 WOODLAND AVE #1 • MODESTO, CALIFORNIA 95351 • (209) 529-4080 • FAX (209) 529-4736

REPORT NUMBER: 00-336-047

CLIENT NO.: 9999-D

SEND TO: A & L WESTERN AGRICULTURAL LABS
1311 WOODLAND AVE.
MODESTO, CA 95351-

SUBMITTED BY:

GROWER: EXAMPLE REPORT

DATE OF REPORT: 04/30/04 PAGE 1

SOIL ANALYSIS REPORT

SAMPLE ID	LAB NUMBER	Organic Matter		Phosphorus		Potassium K **** * ppm	Magnesium Mg *** * ppm	Calcium Ca *** * ppm	Sodium Na *** * ppm	Soil pH	pH	Buffer Index	Hydrogen H meq/100g	Cation Exchange Capacity C.E.C. meq/100g	PERCENT CATION SATURATION (COMPUTED)				
		* Rating	** ENR lbs/A	P1 (Weak Bray) **** * ppm	NaHCO ₃ -P (Olsen Method) **** * ppm										K %	Mg %	Ca %	Na %	
130-1	55931	4.0H	110	23M	14**	110L	460M	992VL	104L	4.7	6.2	6.2	9.7	19.1	1.5	19.8	25.9	50.5	2.4
130-2	55932	1.5L	60	27H	6**	41VL	569M	1154VL	185M	4.6	5.9	5.9	13.3	24.7	0.4	19.0	23.3	54.0	3.3
12-1	55933	3.5M	100	12L	11**	64L	471VH	841VL	87L	5.2	6.5	6.5	4.5	13.1	1.2	29.5	31.9	34.5	2.9
12-2	55934	2.8M	86	8VL	9**	29L	553VH	665VL	89M	5.3	6.6	6.6	3.7	12.1	0.6	37.7	27.5	31.0	3.2

** NaHCO₃-P unreliable at this soil pH

SAMPLE NUMBER	Nitrogen NO ₃ -N ppm	Sulfur SO ₄ -S ppm	Zinc Zn ppm	Manganese Mn ppm	Iron Fe ppm	Copper Cu ppm	Boron B ppm	Excess Lime Rating	Soluble Salts mmhos/cm	Chloride Cl ppm	PARTICLE SIZE ANALYSIS			
											SAND %	SILT %	CLAY %	
130-1	5L	5L	0.3VL	3M	53VH	0.2VL	0.1VL	L	0.3L					
130-2	3VL	41VH	0.1VL	1VL	14M	0.2VL	0.1VL	L	0.6L					
12-1	2VL	5L	0.1VL	2L	50VH	0.1VL	0.3VL	L	0.2VL					
12-2	2VL	4L	0.1VL	1VL	53VH	0.1VL	0.2VL	L	0.1VL					

* CODE TO RATING: VERY LOW (VL), LOW (L), MEDIUM (M), HIGH (H), AND VERY HIGH (VH).
** ENR - ESTIMATED NITROGEN RELEASE
*** MULTIPLY THE RESULTS IN ppm BY 2 TO CONVERT TO LBS. PER ACRE OF THE ELEMENTAL FORM
**** MULTIPLY THE RESULTS IN ppm BY 4.6 TO CONVERT TO LBS. PER ACRE P₂O₅
***** MULTIPLY THE RESULTS IN ppm BY 2.4 TO CONVERT TO LBS. PER ACRE K₂O
MOST SOILS WEIGH TWO (2) MILLION POUNDS (DRY WEIGHT) FOR AN ACRE OF SOIL 6-2/3 INCHES DEEP

MB
Mike Buttress, CPAg
A & L WESTERN LABORATORIES, INC.

This report applies only to the sample(s) tested. Samples are retained a maximum of thirty days after testing.

Figure 3-7: Soil texture report example (image courtesy of A & L Western Agricultural Laboratories)



A & L WESTERN AGRICULTURAL LABORATORIES
 1311 WOODLAND AVE #1 • MODESTO, CALIFORNIA 95351 • (209) 529-4080 • FAX (209) 529-4736

REPORT NUMBER: 08-051-042 **CLIENT:** 3541 **SUBMITTED BY:**
SEND TO: TERRA SPASE **GROWER:** TRUBODY
 345 LA FATA STREET SUITE D
 ST HELENA, CA 94574-

DATE OF REPORT: 03/21/08 **PAGE:** 1

SOIL PHYSICAL CHARACTERISTICS

Sample ID	Lab Number	% Sand	% Silt	% Clay	Soil Texture	Moisture @ 15 Bar	Available Water %
T2-1	52631	43	26	31	CLAY LOAM		
T2-2	52632	51	20	29	SANDY CLAY LOAM		
T2-3	52633	51	22	27	SANDY CLAY LOAM		
T2-4	52634	39	30	31	CLAY LOAM		
T6A-1	52635	19	40	41	SILTY CLAY		
T6A-2	52636	13	34	53	CLAY		
T6A-3	52637	14	33	54	CLAY		

NOTES:

"Our reports and letters are for the exclusive and confidential use of our clients, and may not be reproduced in whole or in part, nor may any reference be made to the work, the result or the company in any advertising, news release, or other public announcements without obtaining our prior written authorization." © Copyright 1977 A & L WESTERN LABORATORIES, INC.

MB
Mike Buttress, CPAg
 A & L WESTERN LABORATORIES, INC.

2.7 Web Soil Survey

- The [Web Soil Survey](https://websoilsurvey.nrcs.usda.gov/)¹ is operated by the USDA Natural Resources Conservation Service (NCRS) and provides maps and data for the majority of the United States.
- The [UC Davis Soil Resource Laboratory](https://casoilresource.lawr.ucdavis.edu/)² provides various SoilWeb apps to access USDA soil survey data for most of the United States.
- While the Web Soil Survey is a useful tool, use caution in urban environments where topsoil may have been removed, replaced and/or amended.

2.8 While the proper identification of soil texture is best performed by a soil laboratory, there are several field tests to determine a preliminary evaluation of soil texture.

Figure 3-8: Sedimentation test

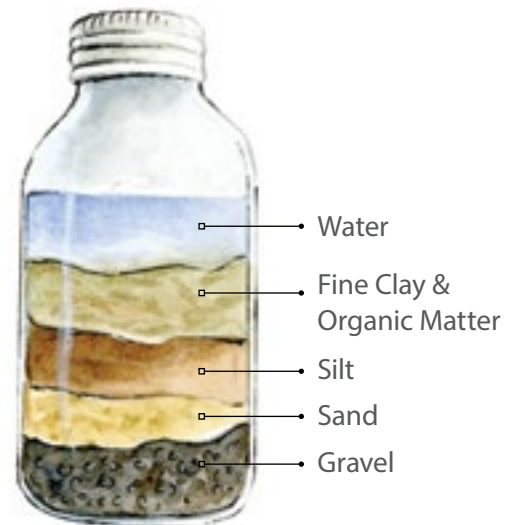

- **Soil sedimentation test** (Figure 3-8).
 - This method depends on the property of soil particles to settle separately when they are placed in water that contains an agent that separates the particles.
 - Place approximately half a cup of soil in a quart jar.
 - Add 3 ½ cups of water and 5 tablespoons of detergent solution to the jar.
 - Detergent solution should be 6-8% Calgon solution (or non-foaming laundry detergent). To make solution, mix 1 tablespoon of detergent per cup of water.
 - The test can also be performed without detergent, but the soil particles will take longer to settle and some will remain in solution.
 - Cap the jar and shake for 60 seconds, then place on a stable surface so that the various soil particles are allowed to settle to the bottom of the jar.
 - Sand particles will settle to the bottom first, followed by silt particles, and then clay. The smallest clay particles will remain in solution.
 - After several hours, measure the thickness of the various bands to provide as an estimate of the proportions of sand, silt, and clay in the soil. It can take 24 hours or more for clay particles to settle out.
 - Note that not all soils contain significant amounts of all three soil separates.
 - Fine to coarse very dark particles either suspended or floating on the water or settled on top of the clay layer are organic matter and do not need to be taken into account for this test.
- Determining soil **texture by “feel”** using the hand (Figure 3-9).
 - Take soil and remove gravel or plant debris.
 - Form soil sample into a half inch ball and wet the soil to make it pliable.
 - Work the soil between the fingers until is uniformly moist without any dry lumps.
 - Note the degree of grittiness which indicates sand; stickiness indicates clay.
 - If the sample can be molded into a ball but breaks at the slightest pressure, the soil is sandy.

¹<https://websoilsurvey.nrcs.usda.gov/>

²<https://casoilresource.lawr.ucdavis.edu/>

Figure 3-9: Texture by “feel” test



- If the soil can be shaped as a ribbon without breaking apart, it indicates various amounts of silt and clay.
- A ribbon less than 1 inch long indicates a type of loam soil.
- A ribbon from 1 to 2 inches indicates a type of clay loam soil.
- A ribbon greater than 2 inches long indicates a type of clay soil.
- An in-depth guide to texture by feel is provided by the United State Department of Agriculture.³

2.9 **Soil structure** refers to the arrangement of soil separates into small structures called **soil aggregates**. Soil structure is important, as it affects **pore size**. Pores within an aggregate are smaller, and those between aggregates are larger. The balance of large and small pore spaces affects soil aeration, permeability, and water holding capacity.

- Aggregates are described by their shape, size and stability.
- Common top soil aggregate types (Figure 3-10) are:
 - Granular (rounded surfaces) – generally considered desirable for horticultural purposes
 - Crumb (larger than granular)
 - Platy (rectangular with long horizontal dimension)
- While soil texture cannot be changed, soil structure can be affected by environmental and maintenance factors.
- Tillage, rain and irrigation, and compaction can break down aggregates and deteriorate soil structure.
- Incorporating organic matter can improve the soil structure of all soil types, including clay and sandy soils.

Figure 3-10: Soil structure from left to right (1) granular, (2) crumb, (3) platy



1. Granular



2. Crumb



3. Platy

³ https://www.nrcs.usda.gov/Internet/FSE_MEDIA/nrcs142p2_050352.jpg

3 HOW WATER INTERACTS WITH DIFFERENT SOIL TYPES

3.1 **Infiltration** is the entry of water into the soil surface. **Percolation** is the flow of water through soil. The **infiltration rate** is the rate at which soil absorbs water from rainfall and irrigation. The **percolation rate** is the rate at which soil moisture moves down the soil profile. Infiltration and percolation rates are governed by **gravity** and **capillary forces**.

- Runoff occurs when the rate at which irrigation water is applied exceeds the rate at which the water can move into the soil.
- Soils dominated by **sand** are considered **light** and have **rapid** infiltration and percolation rates.
- Soils dominated by **clay** are considered **heavy** and have slower infiltration and percolation rates than sandy soils.
- **Loam** is considered ideal for horticultural purposes and the rate at which water infiltrates and percolates is between the rates in sandy or heavy soils.
- Figure 3-11 shows the different **wetted patterns** produced by a 1 gallon per hour drip emitter in three different types of soil.

Figure 3-11: How water travels in soil – wetted pattern of a drip emitter

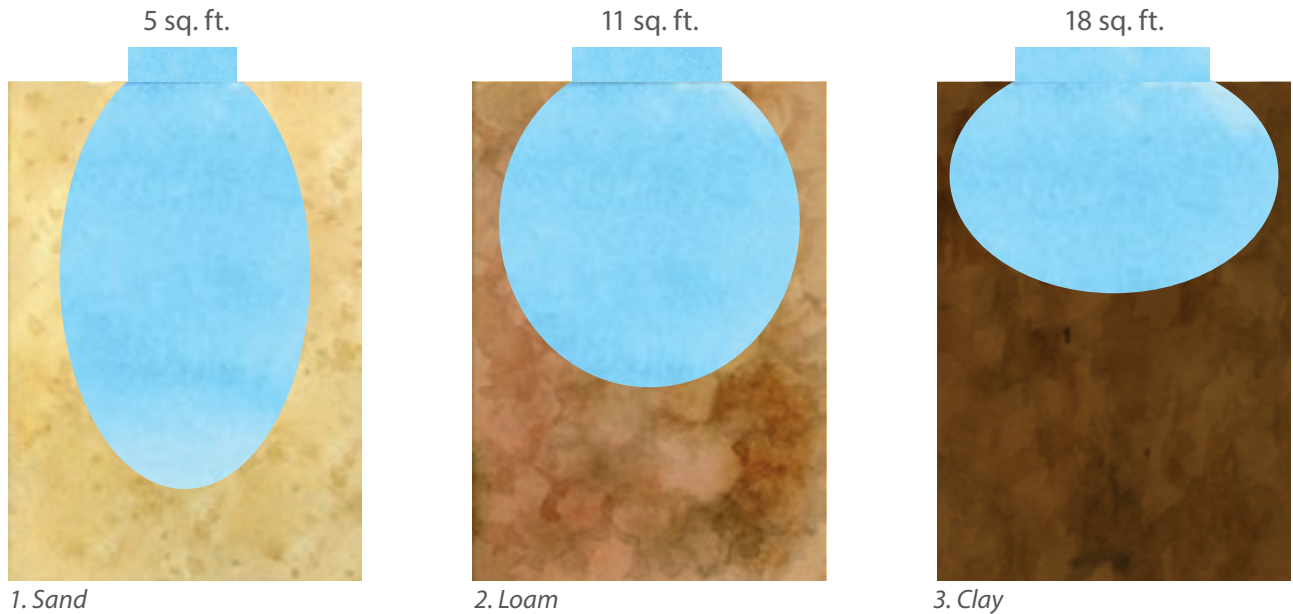

3.2 There are various properties of water that relate to soils and which are important to understand for irrigation:

- A **water molecule** (Figure 3-12) is made up of **2 hydrogen atoms** and **1 oxygen atom**.
- Water molecules form **hydrogen bonds** with each other and are **polar** – the oxygen atom has a slight negative charge and the hydrogen atoms have a slight positive charge.
- **Polarity** is responsible for the **cohesion** of water molecules to each other, and **adhesion** of water to other substances such as soil particles.
- Cohesion results in the **surface tension** of water as illustrated by the formation of water drops on leaf surfaces.

Figure 3-12: Water molecule

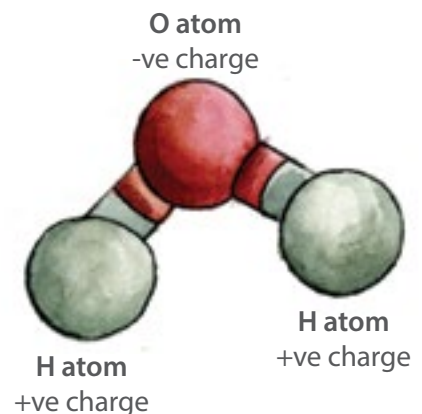

- **Capillary action** results from the forces of cohesion, adhesion, and surface tension as illustrated by water climbing to different levels in glass tubes of varying diameters (Figure 3-13). It enables plants to pull water from the soil up through roots and stems.
- Capillary action is why soil, especially soil with good structure, is able to hold water and move it in directions that are against the force of gravity. Excessive soil compaction collapses the pore spaces in well-structured soil and reduces the soil's capacity for capillary flow.

Figure 3-13: Capillary action (image courtesy of United States Department of Agriculture)

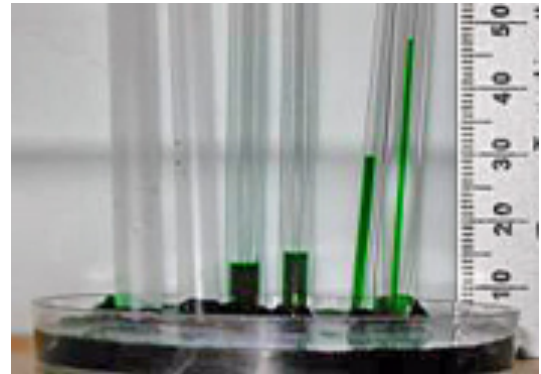

3.3 These considerations are important for irrigation (Figure 3-14):

- Not all of the water in the soil is available to plants because some of it is held too tightly by soil particles for plant roots to absorb.
- Plants require **available water**, which is water in the soil that can be absorbed by plant roots.
- After abundant water is applied to the soil, most pores are filled with water and the soil reaches the **saturation point**.
- In a saturated soil, some water is pulled down further by gravity. This is **gravitational water**. Water clinging to soil particles resists the force of gravity.
- After the gravitational water infiltrates deep into the soil, the soil reaches **field capacity**.
- When most of the available water from the soil is depleted, the soil is considered to be at the **wilting point**. Plant stress is noticeable at this point and may show as discoloration or weakened structure. Irrigation needs to be applied prior to the **permanent wilting point** (plant death).
- **Hygroscopic water** is water formed in very thin films around soil particles. It is not available to plants because it is held too tightly by the soil to be accessible to plant roots.
- The goal of irrigation is to restore soil moisture to field capacity and to maintain soil moisture well above wilting point

Figure 3-14: The soil moisture reservoir

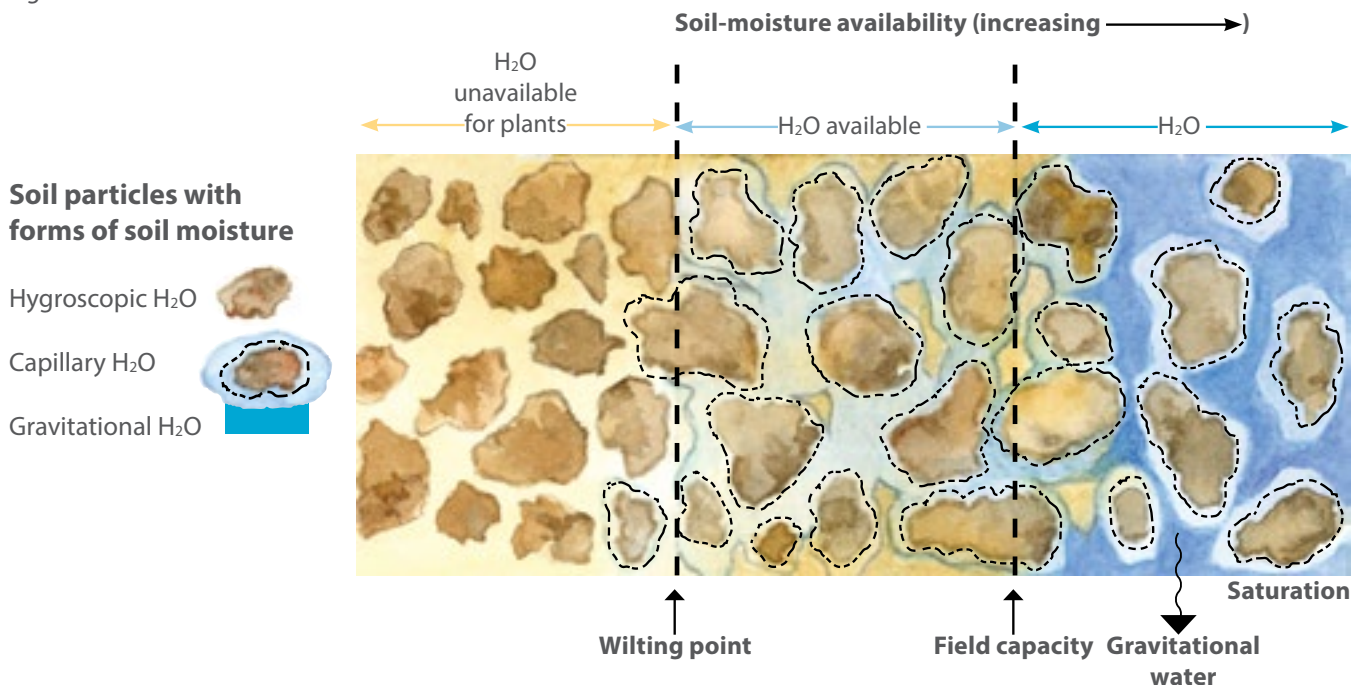

3.4 Soils retain water depending on **texture**, structure and **organic matter** content (Figure 3-15).

- Water and air are stored in **pore space** between soil particles.
- Clay soils hold the most water at field capacity, whereas sandy soils hold the least.
- Loam soils have the most available water since water molecules are held more tightly in clay soils due to their smaller pore spaces.

Figure 3-15: Soil water (image courtesy of Soil Quality Pty Ltd)

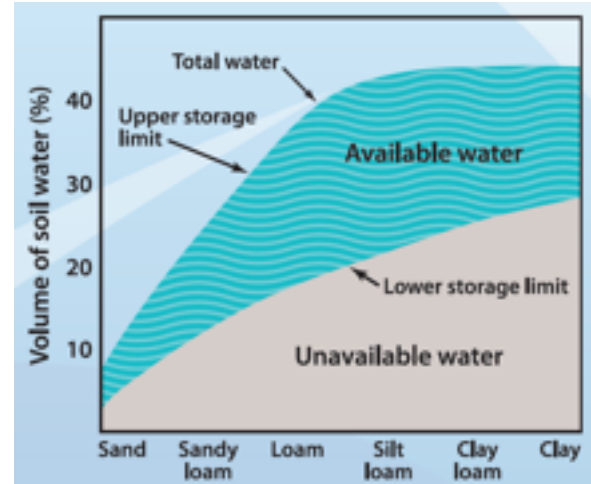

3.5 Plant-available water holding capacity of various soil textures (Table 3-2).

Table 3-2: Available water holding capacity of various soil textures

Soil Texture	Plant-available Water Holding Capacity (inches of water per foot of soil)
Very coarse sands	0.4 - 0.75
Coarse sands, fine sands, loamy sands	0.75 - 1.25
Sandy loams, fine sandy loams	1.25 - 1.75
Very fine sandy loams, loams, silt loams	1.50 - 2.30
Clay loams, silty clay loams, sandy clay loams	1.75 - 2.50
Sandy clays, silty clays, clays	1.60 - 2.50

3.6 Available water holding capacity is **dynamic** and is affected by factors such as organic matter content and compaction of the soil.

- Organic matter increases a soil’s ability to hold water for plant use. Organic matter also improves soil structure and aggregate stability, resulting in increased pore size and volume.
- Compaction is covered below in 5. Common Soil Issues.

3.7 **Leaching** is the process whereby water-soluble plant nutrients, minerals, and chemicals are lost from the soil due to excessive rain and/or irrigation.

- Leaching of fertilizer and other products in the soil is an important environmental concern and can have negative impacts on groundwater, surface water, and the ocean.
- Nitrate leaching is a source of soil acidification.
- Salt removal is a beneficial application of leaching. The practice of applying excess irrigation water can be used to prevent salt buildup in the soil.

5 COMMON SOIL ISSUES

5.1 **Soil compaction** (Figure 3-19) occurs when soil particles are pressed together due to factors such as heavy machinery, foot traffic, and excessive tillage.

- Compacted soils contain less air and are less porous than well-aerated, friable soils.
- Compacted soils have relatively few large pores, resulting in a lower water holding capacity, a slower infiltration rate, and less oxygen for plant roots, all of which can cause issues for the health of plants in the landscape.
- Compaction is a significant issue in urban areas. In construction projects, it is common in specifications for landscape areas to allow for up to 85% compaction of soils, as opposed to the approximately 50% compaction recommended for optimal plant growth. Techniques aimed at reducing compaction, both prior to planting and as part of ongoing maintenance can provide a huge benefit to the structure and water holding capacity of soils.
- Saturated soils are particularly prone to compaction. Exercise caution when working with saturated soils to prevent excessive compaction.

Figure 3-19: Soil compaction

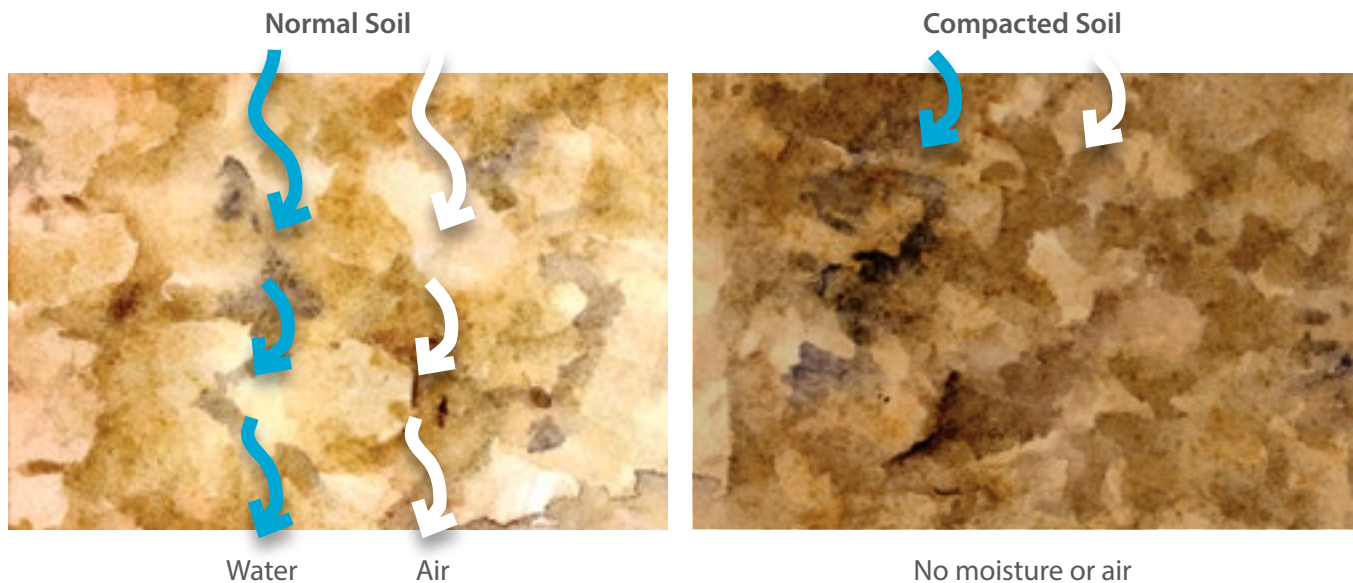

5.2 **Erosion** is the removal of soil layers caused by wind, rain, or irrigation hitting **bare soil** not covered by vegetation or mulch.

- Slopes are particularly susceptible to erosion.
- Prevent soil erosion by:
 - **Covering soils** with vegetation or mulch. Plant roots are highly effective at stabilizing soils.
 - Avoiding runoff during irrigation by **matching the application rate of the irrigation system with the infiltration rate of the soil** and/or using **multiple irrigation start times** spaced to give sufficient time for the water to infiltrate (cycle and soak).
 - Not applying more water than can infiltrate into the soil.
 - **Improving soil structure** with the addition of organic matter. Optimal soil structure will increase the infiltration rate and water holding capacity of the soil.

5.3 **Soil pH** describes the relative **acidity** or **alkalinity** of the soil and is important to understand because it affects **plant nutrient availability** (Figure 3-20).

- A pH of 7.0 is neutral.
- Soil pH levels that are too high or too low lead to deficiency of many nutrients, decline in microbial activity, and a decrease in plant and soil health.
 - Soil acidification can be accelerated by the inefficient use of nitrogen fertilizers, and acid rain.
 - Alkaline soils may be caused by calcium carbonate-rich parent material weathering in an arid environment.
 - A soil pH in the range of **6 to 7.5** is considered ideal for nutrient availability for most plants. At pH levels outside of this range the availability of critical nutrients may be reduced, which may inhibit plant growth; or the availability of certain micronutrients may increase to levels that are toxic to many plants (Figure 3-18).
 - Some plants have evolved to survive and thrive outside of the 6 to 7.5 pH range. For example, blueberries, and azaleas prefer more acidic soils.
- Soil pH can be determined through a soil laboratory test or by using off-the-shelf test kits.
- **Changing soil pH can be challenging**, may take several years, and may yield temporary results. When possible, it is recommended to select plants that thrive in the known pH.
 - Periodically adding small amounts of micronutrients may be more cost effective than attempting to change pH.
 - The addition of organic matter over time through compost, mulch, and other plant residues has some ability to ameliorate pH issues.

Figure 3-20: pH and nutrient availability (image courtesy of growing-life.com)

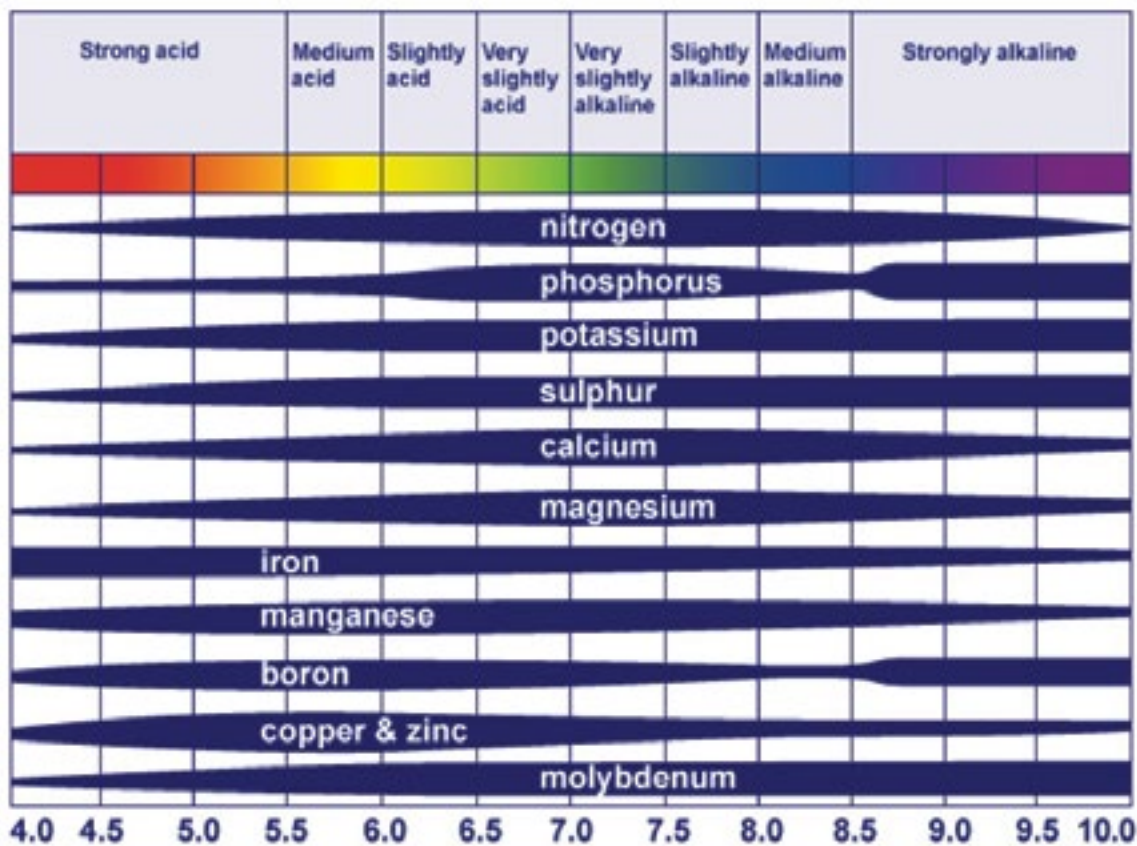

- Lowering pH.
 - The addition of acidic organic matter such as pine needles gradually lowers pH over time as it decomposes and contributes small amounts of acid to the soil.
 - Elemental sulfur (90-99% sulfur) oxidizes slowly to form sulfuric acid in soil, so direct application of elemental sulfur, as well as liquid acids, has the potential to temporarily lower soil pH, though this is limited by cost and by the buffering capacity of native lime in the soil.
- Raising pH.
 - Ground limestone or other liming materials have the ability to raise pH. Soils with a higher proportion of clay require proportionately more limestone to raise the pH.

5.4 Salinity in soils.

- **Salinity** is a measurement of the total amount of soluble salts in the soil.
- As soluble salt levels increase, it becomes more difficult for plants to extract water from soil. Some plants are more resistant than others, but as salt levels increase, their ability to extract water decreases until they become water stressed.
 - This is known as chemical drought, since affected plants show visual symptoms similar to those of plants suffering from a lack of water.
- There are different kinds of salts in the soil, including fertilizers and all kinds of minerals.
- Sodium (table salt) is one of the most troublesome soil salts. **Soil sodicity** can be a more serious problem than other types of soil salinity because sodicity causes not only chemical changes, but also physical changes to the soil structure. When soil sodicity occurs, clay particles separate and block the spaces in the soil structure, inhibiting water infiltration and air circulation. The soil hardens and cracks when dry and is slippery mud when wet. Sodic soils can be amended by applying gypsum to improve soil structure. Sodic soils should be identified by a lab.
- Salt-affected soils are common in arid climates where there is insufficient rainfall to flush salts from the upper soil layers and high evaporation.
- Salinity in soils can be worsened by:
 - Excessive fertilizer.
 - Runoff from road and sidewalk deicer.
 - Poor soil drainage.
 - Poor irrigation water quality.
 - Improper irrigation (frequent short increments).
- Methods for dealing with saline soils include:
 - Leaching if there is adequate drainage and a clean source of irrigation water available.
 - Application of gypsum and sulfur can help in leaching sodium from the root zone of identified sodic soils.
 - Using salt-tolerant plant species.

6 MULCH AND SOIL AMENDMENTS

6.1 **Mulch** refers to material placed on top of the soil, whereas **soil amendments** are worked into the soil.

6.2 Mulch (Figure 3-21) can be made from **organic matter** (such as wood chips, leaves, or grass clippings) or **inorganic matter** (such as pebbles or gravel). Mulch should be applied to a depth of **2 to 4 inches** and should be kept away from the crown of the plant.

- Organic mulch is not incorporated into the soil because the process of decomposition would result in significant amounts of nitrogen being tied up and unavailable to plants.
- Organic mulch will need to be reapplied periodically since it gradually breaks down and is incorporated into the soil.
- Plastic mulch should be avoided as it does not promote healthy living soil and eventually breaks down into small pieces that result in pollution.

6.3 To benefit ground nesting pollinators, leave some areas without mulch.

6.4 The benefits of mulch include:

- Inhibit weed seed germination and weed growth.
- Retain soil moisture by reducing evaporation from the soil surface.
- Gradual addition of organic matter to the soil as organic mulch breaks down and helps to maintain an active soil food web.
- Reduction in soil compaction and improvement in soil structure.
- Moderation of soil temperature.
- Reduction of soil erosion.

Figure 3-21: Arbor mulch



6.5 **Soil amendments** (Figure 3-22) are frequently used to improve soil structure, fertility, and water holding capacity. Examples include:

- **Compost** to improve soil structure. The addition of organic matter can improve the water holding capacity of sandy soils and the aggregation of clay soils.
- **Biochar** has various benefits as a soil amendment including enhancing the stability and fertility of soils, as well as long-term **carbon sequestration**.
- **Composted aged manure** is frequently used to add organic matter and nutrients to soils. Manure should be aged and not green. Manure can contain weed seeds and have high salt levels.
- **Lime** is used to raise the pH of acidic soils.
- **Gypsum** can benefit soils with a high sodium and alkalinity content. Following a soil test, apply gypsum at the recommended rate.
- **Polymers** can be added to the soil to improve water holding capacity in some instances, thereby potentially reducing the required frequency of watering.

Figure 3-22: Compost



7 SOILS REVIEW QUESTIONS

- 7.1 What are the four major components of soil?
- 7.2 What is soil texture and what are the three types of soil separates/particles?
- 7.3 How many soil textural classes are there?
- 7.4 What are the steps for using the soil textural triangle?
- 7.5 True or false: texture by feel and the soil sedimentation test can be used in the field for a preliminary evaluation of soil texture.
- 7.6 What is soil structure and why is it important?
- 7.7 True or false: Soils dominated by clay are considered heavy and generally have slower infiltration and percolation rates than sandy soils.
- 7.8 True or false: Loam is considered ideal for horticultural purposes because the rate at which water infiltrates and percolates is generally between the rates in sandy or heavy soils.
- 7.9 What is the term used to describe the ability of plants to pull water and dissolved nutrients from the soil up through roots and stems?
- 7.10 What is the term that describes the total amount of water stored in the soil after gravitational water infiltrates deep into the soil profile?
- 7.11 True or false: Loam soils have more available water than clay soils, as water molecules are held more tightly in clay soils due to the predominance of smaller pore spaces.
- 7.12 Name three devices used to monitor soil moisture.
- 7.13 Why is soil compaction a concern?
- 7.14 How can soil erosion be prevented?
- 7.15 True or false: A soil pH in the range of 6 to 7.5 is considered ideal for nutrient availability for most plants.
- 7.16 True or false: Salt-affected soils are common in arid climates.
- 7.17 What is the difference between mulch and soil amendments?

Section 4:
**LANDSCAPE
WATER**





LANDSCAPE WATER

Learning Objectives

1. Understand the concept of a landscape water budget
2. Have a basic understanding of evapotranspiration
3. Be familiar with sources of evapotranspiration and weather station information
4. Understand plant water use classifications
5. Understand hydrozones and the selection of plants based on various uses and other factors
6. Learn how to calculate a basic landscape water budget
7. Learn how to calculate how much irrigation water to apply
8. Understand key issues for developing a water budget for a landscape site
9. Examples of water budgets

1 LANDSCAPE WATER BUDGET CONCEPT

- 1.1 A **landscape water budget** (water budget) is an estimate of how much water is needed to maintain a healthy landscape for a given time period.
- 1.2 Water budgets are an essential tool in planning and managing landscape water use.
- 1.3 There are three elements to a basic water budget:
 - Weather
 - Plant Type
 - Area

$$\text{Water Budget} = \text{Weather} \times \text{Plant Type} \times \text{Area}$$

2 EVAPOTRANSPIRATION

- 2.1 **Evapotranspiration** (ET) is an important component of the water cycle. It is the loss of water to the atmosphere by the combined processes of **evaporation** (from soil and plant surfaces) and **transpiration** (through plant tissues) (Figure 4-1).

Figure 4-1: Evapotranspiration

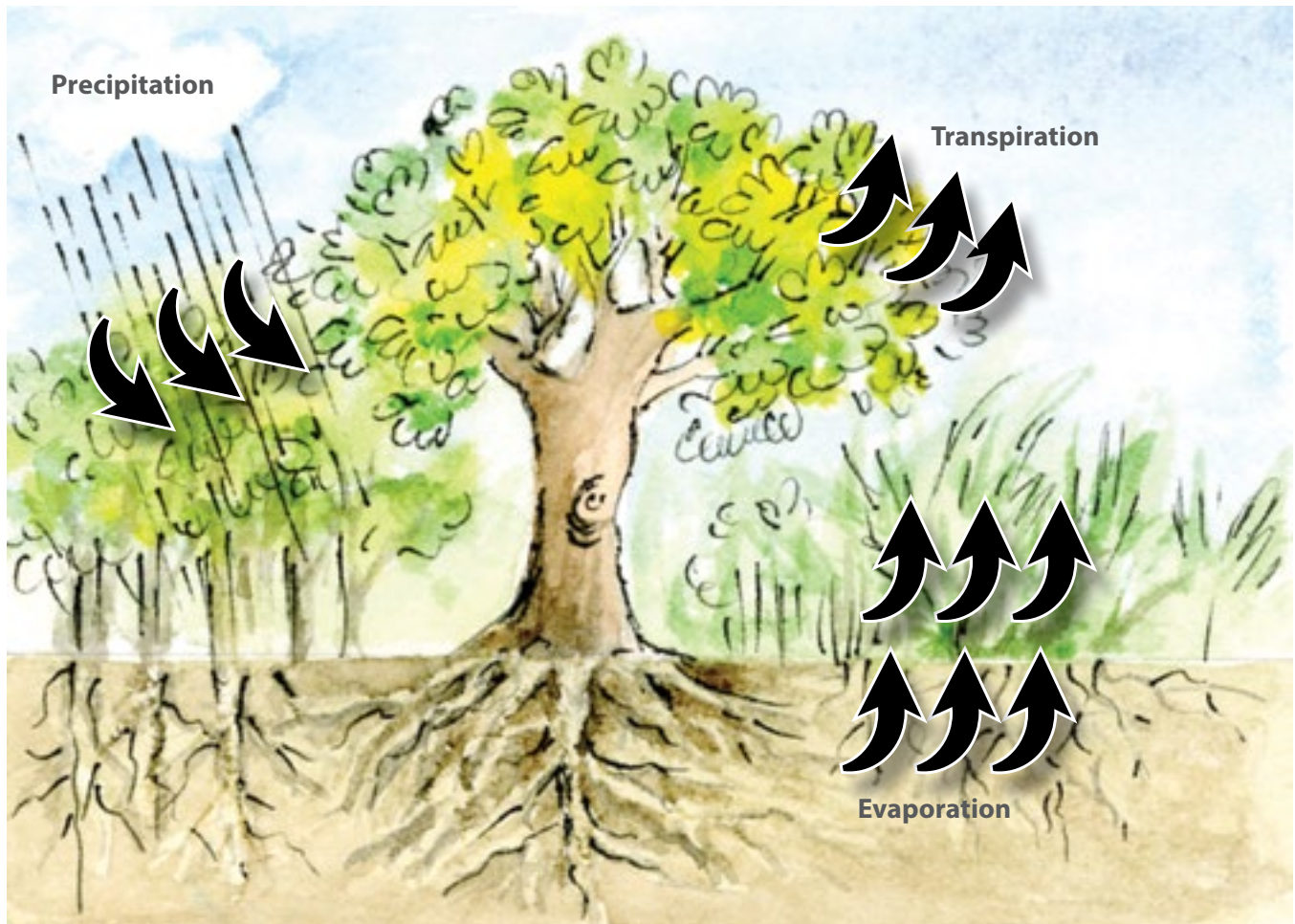

2.2 ET changes as the weather changes and is affected by many factors, including:

- Solar radiation - light energy that comes from the sun. It varies by geographic location, time of day, season, weather, and due to factors such as shade.
- Air temperature.
- Relative humidity.
- Wind speed.
- Soil exposure.
- Planting density. Transpiration is directly related to the amount of leaf surface area within a given area. Areas with more dense planting have more transpiration than sparse plantings.

2.3 Reference ET is the ET rate of a reference crop expressed in inches.

- The landscape industry uses ET from a well-watered cool season turfgrass maintained at 4 to 6 inches tall as the reference (ET_o).
 - Cool season turfgrass is used as the reference crop because it may be grown and managed consistently in a wide variety of locations, allowing meaningful comparisons.

2.4 ET_o is the reference point for landscape plant water use calculations and represents the weather component when calculating a water budget.

2.5 ET_o can be measured using any available time period, e.g. hourly, daily, weekly, monthly, or annually.

3 SOURCES OF ET_o AND WEATHER STATION INFORMATION

3.1 A source of reliable and accurate ET_o data is essential to accurately perform plant and landscape water requirement calculations.

- Weather stations are used to obtain the data required to calculate ET_o.
- Daily ET_o data is preferred to provide the most accurate estimation of plant water requirement.
- If such data is not available, historical averages can be used. NOAA¹ and state climate centers are good resources for historical data.

3.2 Typical measurements taken by weather stations (Figure 4-2) include:

- Solar radiation (pyranometer)
- Soil and air temperature (thermistor)
- Relative humidity (probe)
- Wind direction (wind vane)
- Wind speed (anemometer)
- Precipitation (tipping-bucket rain gauge)

Figure 4-2: Weather station



¹www.ncdc.noaa.gov/

- 3.3 The EPA WaterSense [Water Budget Data Finder](https://www.epa.gov/watersense/water-budget-data-finder)² can be used to determine peak watering month and the estimated ET and rainfall values for a specific United States zip code.
- The Water Budget Data Finder relies on historic information collected from 1961 to 1990.
- 3.4 **California:** The [California Irrigation Management Information System](http://www.cimis.water.ca.gov/) (CIMIS) is a program operated by the [California Department of Water Resources](http://www.water.ca.gov/) (DWR) to provide ETo and other climate related data.
- CIMIS is a network of over 145 automated weather stations in California.
 - CIMIS was developed in 1982 by DWR and the University of California, Davis (UC Davis). It was designed to assist irrigators in managing their water resources more efficiently.
 - The [CIMIS website](http://www.cimis.water.ca.gov/)³ provides users with free access to CIMIS data collected from 1989 to present.
 - CIMIS weather stations are frequently located in areas with irrigated turfgrass such as golf courses, cemeteries, and playing fields.

Figure 4-3a: CIMIS ETo zones (California Department of Water Resources)

Reference Evapotranspiration Zones	
1	COASTAL PLAINS HEAVY FOG BELT lowest ETo in California, characterized by dense fog
2	COASTAL MIXED FOG AREA less fog and higher ETo than zone 1
3	COASTAL VALLEYS & PLAINS & NORTH COAST MOUNTAINS more sunlight than zone 2
4	SOUTH COAST INLAND PLAINS & MOUNTAINS NORTH OF SAN FRANCISCO more sunlight and higher summer ETo than zone 3
5	NORTHERN INLAND VALLEYS valleys north of San Francisco
6	UPLAND CENTRAL COAST & LOS ANGELES BASIN higher elevation coastal areas
7	NORTHEASTERN PLAINS
8	INLAND SAN FRANCISCO BAY AREA inland area near San Francisco with some marine influence
9	SOUTH COAST MARINE TO DESERT TRANSITION inland area between marine & desert climates
10	NORTH CENTRAL PLATEAU & CENTRAL COAST RANGE cool, high elevation areas with strong summer sunlight; zone has limited climate data & the zones selection is somewhat subjective
11	CENTRAL SIERRA NEVADA mountain valleys east of Sacramento with some influence from delta breeze in summer
12	EAST SIDE SACRAMENTO - SAN JOAQUIN VALLEY low winter & high summer ETo, slightly lower ETo than zone 14
13	NORTHERN SIERRA NEVADA northern Sierra Nevada mountain valleys with less marine influence than zone 11
14	MID-CENTRAL VALLEY, SOUTHERN SIERRA NEVADA, TEHACHAPI & HIGH DESERT MOUNTAINS high summer sunshine and wind in some locations
15	NORTHERN & SOUTHERN SAN JOAQUIN VALLEY slightly lower winter ETo due to fog and slightly higher summer ETo than zones 12 & 14
16	WESTSIDE SAN JOAQUIN VALLEY & MOUNTAINS EAST & WEST OF IMPERIAL VALLEY
17	HIGH DESERT VALLEYS valleys in the high desert near Nevada and Arizona
18	IMPERIAL VALLEY, DEATH VALLEY & PALO VERDE low desert areas with high sunlight & considerable heat advection

² <https://www.epa.gov/watersense/water-budget-data-finder>

³ <http://www.cimis.water.ca.gov/>

- Most of California has a Mediterranean climate characterized by hot dry summer months and cooler winter months with periods of rain. A Mediterranean climate is different than a more arid desert climate.
- CIMIS has divided California into **18 climatic zones** as shown in Figure 4-3.
- The **peak irrigation month** for most climate zones in California is July.
- Peak monthly average ETo in California ranges from 4.65 inches in zone 1 to almost 10 inches in zones 17 and 18.
- Figure 4-4 provides some examples of monthly average ETo by climatic zone.
- Figure 4-5 provides an example of average historical ETo and precipitation by month for CIMIS station 83 in Santa Rosa (zone 5) for the period 1990 to 2015.

Figure 4-3b: CIMIS ETo zones (California Department of Water Resources)

Monthly Average Reference Evapotranspiration by ETo Zone (inches/month)													
Zone	Jan	Feb	Mar	Apr	May	Jun	Jul	Aug	Sep	Oct	Nov	Dec	Total
1	0.93	1.40	2.48	3.30	4.03	4.50	4.65	4.03	3.30	2.48	1.20	0.62	32.9
2	1.24	1.68	3.10	3.90	4.65	5.10	4.96	4.65	3.90	2.79	1.80	1.24	39.0
3	1.86	2.24	3.72	4.80	5.27	5.70	5.58	5.27	4.20	3.41	2.40	1.86	46.3
4	1.86	2.24	3.41	4.50	5.27	5.70	5.89	5.58	4.50	3.41	2.40	1.86	46.6
5	0.93	1.68	2.79	4.20	5.58	6.30	6.51	5.89	4.50	3.10	1.50	0.93	43.9
6	1.86	2.24	3.41	4.80	5.58	6.30	6.51	6.20	4.80	3.72	2.40	1.86	49.7
7	0.62	1.40	2.48	3.90	5.27	6.30	7.44	6.51	4.80	2.79	1.20	0.62	43.3
8	1.24	1.68	3.41	4.80	6.20	6.90	7.44	6.51	5.10	3.41	1.80	0.93	49.4
9	2.17	2.80	4.03	5.10	5.89	6.60	7.44	6.82	5.70	4.03	2.70	1.86	55.1
10	0.93	1.68	3.10	4.50	5.89	7.20	8.06	7.13	5.10	3.10	1.50	0.93	49.1
11	1.55	2.24	3.10	4.50	5.89	7.20	8.06	7.44	5.70	3.72	2.10	1.55	53.1
12	1.24	1.96	3.41	5.10	6.82	7.80	8.06	7.13	5.40	3.72	1.80	0.93	53.4
13	1.24	1.96	3.10	4.80	6.51	7.80	8.99	7.75	5.70	3.72	1.80	0.93	54.3
14	1.55	2.24	3.72	5.10	6.82	7.80	8.68	7.75	5.70	4.03	2.10	1.55	57.0
15	1.24	2.24	3.72	5.70	7.44	8.10	8.68	7.75	5.70	4.03	2.10	1.24	57.9
16	1.55	2.52	4.03	5.70	7.75	8.70	9.30	8.37	6.30	4.34	2.40	1.55	62.5
17	1.86	2.80	4.65	6.00	8.06	9.00	9.92	8.68	6.60	4.34	2.70	1.86	66.5
18	2.48	3.36	5.27	6.90	8.68	9.60	9.61	8.68	6.90	4.96	3.00	2.17	71.6

Figure 4-4: Examples of monthly ETo by climatic zone in California (average 1990 to 2015)

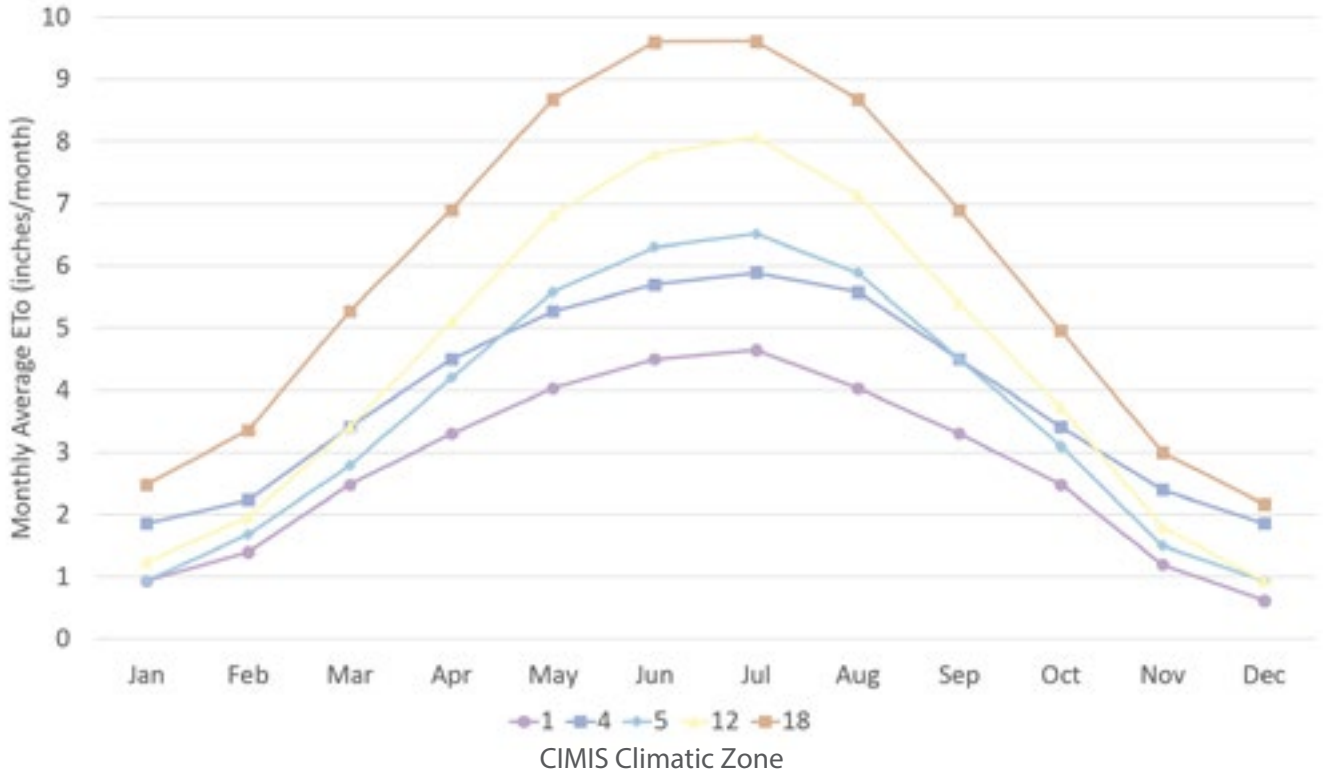
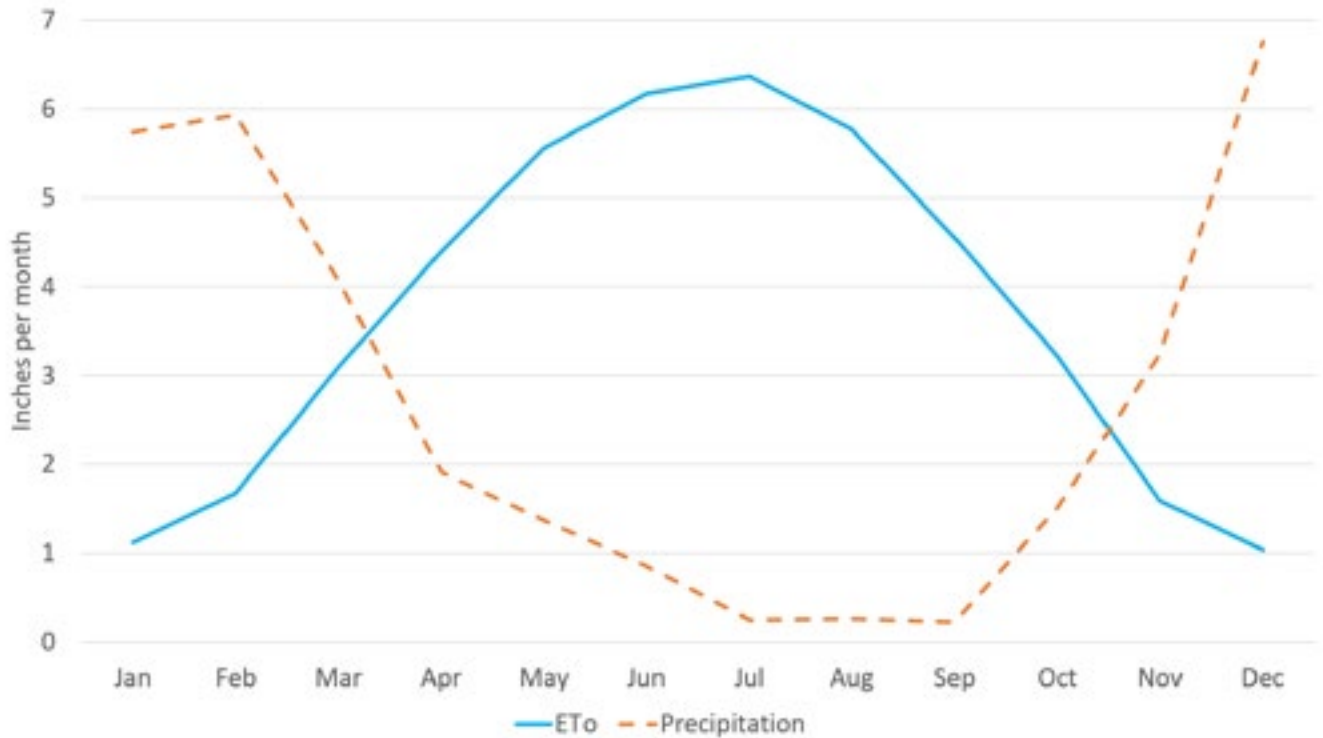

Figure 4-5: CIMIS station 83 ETo and precipitation for Santa Rosa (average 1990 to 2015)



4 PLANT WATER USE CLASSIFICATIONS

- 4.1 Different plant species require different amounts of water to remain healthy. The water requirement of a plant species may be expressed as a **percentage of ETo** and is referred to as a **plant factor (PF)**.
- PF represents the plant type component when calculating a water budget.
 - Plants are often categorized as having water needs that are high, moderate, low, or very low; or by plant type, e.g. trees, shrubs, perennials, turfgrass.
- 4.2 The EPA WaterSense Water Budget Tool uses the following classifications.

Table 4-1: EPA WaterSense Water Budget Tool plant factors

Plant Type	Low (%)	Medium (%)	High (%)
Trees	20	50	90
Shrubs	20	50	70
Groundcover	20	50	70
Turfgrass	60	70	80

- 4.3 **California:** The **Water Use Classification of Landscape Species⁴** (WUCOLS) provides plant water use classifications for 3,500 plants in California. WUCOLS was initiated and funded by the California Department of Water Resources (DWR).
- Table 4-2 shows the WUCOLS categories and percentage of ETo required.

Table 4-2: WUCOLS plant water use classifications

Category	% of ETo	Examples
High (H)	70 - 90	Turf, annuals, willows, and redwoods
Moderate (M)	40 – 60	Many common ornamentals, fruit trees, roses, and perennials
Low (L)	10 – 30	Many California natives, Mediterranean, and low water use plants
Very low (VL)	< 10	Highly drought tolerant species

- For each plant WUCOLS provides classifications for **six climatic regions** (Table 4-3).
- This is useful because a plant’s water use category can change depending on its region number. For example, many plants that are assigned to the low water use category in coastal areas become moderate water use category plants when grown inland.
- WaterWonk is a website that provides an online search tool using the WUCOLS data set.⁵

⁴ <https://ucanr.edu/sites/WUCOLS/>

⁵ <http://www.waterwonk.us/>

Table 4-3: WUCOLS climatic regions (2014)

Region	WUCOLS Region	Sunset Climate Zones	CIMIS Zones	Representative Cities
1	North-Central Coastal	14, 15, 16, 17	1, 2, 3, 4, 6, 8	Healdsburg, Napa, San Jose, Salinas, San Francisco, San Luis Obispo
2	Central Valley	8, 9, 14	12, 14, 15, 16	Auburn, Bakersfield, Chico, Fresno, Modesto, Sacramento
3	South Coastal	22, 23, 24	1, 2, 4, 6	Irvine, Los Angeles, Santa Barbara, Ventura, Vista
4	South Inland	18, 19, 20, 21	9	Corona, Escondido, Pasadena, Riverside, San Bernardino, Santa Paula
5	High and Intermediate Desert	11	14, 17	Apple Valley, Barstow, Bishop, Lancaster, Lone Pine, Tehachapi
6	Low Desert	13	18	Borrego Springs, Blythe, Death Valley, El Centro, Needles, Palm Springs

4.4 Some areas provide guidelines on the water needs of various plant species, whereas in other areas it might be necessary to utilize other resources to determine a plant’s water use. A few useful resources include:

- University research
- Local Master Gardeners
- Local plant nurseries
- City/agency publications and websites
- Sunset Western Garden Book

4.5 Many plants have **identifying characteristics** that are indicators of water use (Figure 4-6).

- Plants adapted to a summer-dry climate may go summer dormant to survive drought conditions.
- Mediterranean plants have adaptations such as hard leathery leaves, small leaves, deep taproots, and fibrous roots.
- Waxy or hairy leaves, and grey foliage, are water conserving features for plants.
- Succulents have fleshy stems and leaves that can absorb and store water.
- Higher water use plants often have large soft leaves, large flowers, or shallow fleshy roots.
 - If required, concentrate higher water use plants in high use/visibility areas where they can have the greatest aesthetic impact within a small irrigated area.
- Many **edible plants** have a low or moderate water use classification. Examples include pomegranate, peach, and plum. Using water to grow food is a highly beneficial use and reduces the need for industrial production and transport of that food.

Figure 4-6: Low water use plants left to right: (1) Ceanothus, (2) Chalk Dudleya, (3) Coast Live Oak, (4) White Sage



5 HYDROZONES AND PLANT SELECTION

5.1 A **hydrozone** is a group of plants with the same water use classification and microclimate assigned to a **single irrigation valve**. Plants should be grouped and planted in separate hydrozones due to factors such as:

- Plant water use classification (Figure 4-7).
- Root depth.
- Microclimate (sun, shade, wind, heat).
- Slope and elevation.
- Soil type.
- Irrigation emission devices with different application rates.
- Summer-dry adapted plants should be on a different hydrozone to those that require more summer moisture.

Figure 4-7: Hydrozone example

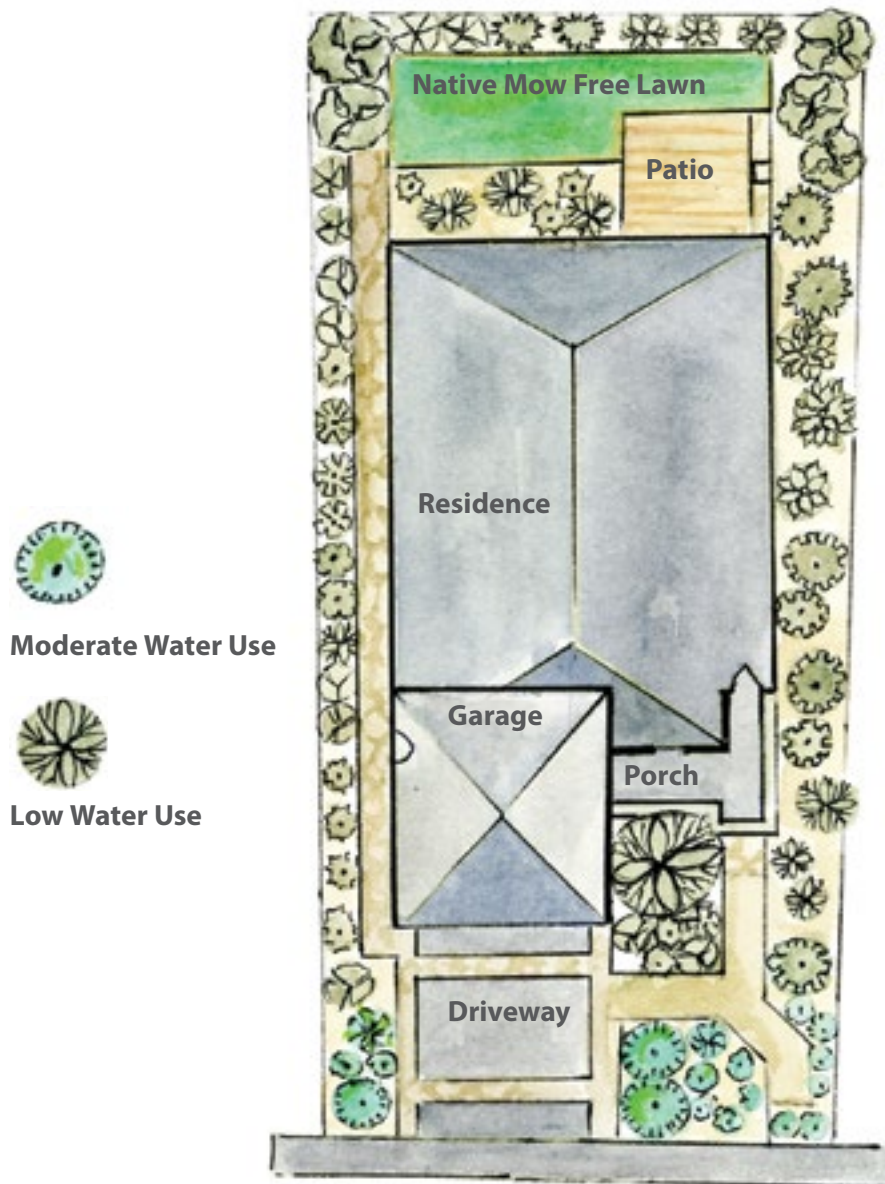

- 5.2 The **landscape area** or hydrozone area represents the area component used when calculating a water budget.
- 5.3 Never mix high water use plants with moderate or low water use plants on the same hydrozone. Where a landscape planting area must contain species with different water use classifications, the highest plant water use classification determines the plant factor for the entire hydrozone.
- For example, a 500 sq ft area irrigated with a single valve that contains 250 sq ft of low water use plants and 250 sq ft of moderate water use plants would be considered a moderate water use hydrozone.
 - This practice will result in water waste, as the lower water use plants will receive more water than required.
 - This can also lead to plant health issues and premature plant death, especially for many Mediterranean and California native plants.
- 5.4 Additional considerations relating to plant selection include:
- Environmental site conditions.
 - Select plants that will thrive in the existing microclimate, considering factors such as sun exposure, prevailing winds, temperature range, precipitation, topography, soil type, and soil pH.
 - Changing the site to fit the plant can be expensive and may ultimately be unsuccessful.
 - Mature plant size, growth rate, and management characteristics.
 - Select plants that will achieve the desired size at maturity, and avoid plants that will out-grow their planting area. Failure to do so will lead to excessive pruning, more water use, a weaker plant, and utilization of more resources.
 - Do not plant directly in front of sprinklers, as potential blocking will lead to poor distribution uniformity, runoff, and overwatering.
 - Plant function.
 - Consider the desired function of the plant, such as screening undesirable views, enhancing privacy, blocking wind, providing shade, preventing erosion, firescaping, providing wildlife habitat, or providing an area for recreation, e.g. deciduous trees provide summer shade and allow light and warmth in winter.
 - Regulations which influence plant selection. Check local codes and regulations.
 - Limited turf areas.
 - Design review of new landscapes.
 - Native plant requirement.
 - Water budget limitations.
 - Irrigation restrictions.

6 WATER BUDGET CALCULATION

- 6.1 The calculation of a basic water budget formula multiplies reference evapotranspiration (ET_o), the plant factor (PF), and the landscape area (LA). The result is multiplied by a constant of 0.62 to [convert from inches into gallons](#) (7.48 gallons per cubic foot divided by 12 to convert ET_o from inches to feet).

$$\text{Water Budget} = \text{Weather} \times \text{Plant Type} \times \text{Area}$$

$$\text{Water Budget} = \text{ET}_o \times \text{PF} \times \text{LA} \times 0.62$$

6.2 Water budget examples.

- 1,000 sq ft landscape area, PF of 0.8, peak monthly ET_o of 6 inches
Water Budget = $6 \times 0.8 \times 1,000 \times 0.62 = 2,976$ gallons
- 500 sq ft landscape area, PF of 0.8, peak monthly ET_o of 6 inches
Water Budget = $6 \times 0.8 \times 500 \times 0.62 = 1,488$ gallons
- 1,000 sq ft landscape area, PF of 0.2, peak monthly ET_o of 6 inches
Water Budget = $6 \times 0.2 \times 1,000 \times 0.62 = 744$ gallons

6.3 [California](#): Table 4-4 shows the annual water budget range using the example of a 1,000 square foot landscape in California.

- There is a dramatic difference between the amount of water required to sustain high and moderate water use plants compared to low and very low water use plants.
- This is compounded by the fact that many California native and Mediterranean plant species are adapted to a summer-dry climate and do not require the amount of summer irrigation indicated by the calculations.
- With conscientious landscape design, it is possible to maintain a landscape that, when mature, can thrive without supplemental irrigation.

Table 4-4: Annual water budget range for a 1,000 sq. ft. landscape in California

Category	PF	Annual ET _o (inches)	Approximate Water Budget (gallons)
High	0.8	32.9 – 71.6	16,000 – 35,500
Moderate	0.5		10,000 – 22,000
Low	0.2		4,000 – 9,000
Very low	0.05		1,000 – 2,000

7 IRRIGATION WATER REQUIREMENT

- 7.1 Precipitation in the form of rainfall reduces the need for supplemental irrigation. But not all rain that falls is absorbed by the soil to become available to plants. **Effective precipitation (EP)** is an estimate of the amount of rain that enters the soil and is available to plants.
- EP is less than actual rainfall for several reasons. Small amounts of rain do not infiltrate into the soil. Conversely, when rain is intense, a significant proportion will run off into the storm drain system or be lost to deep percolation.
 - The EPA WaterSense Water Budget Tool estimates effective precipitation as 25% of average peak monthly rainfall.
 - California's Model Water Efficient Landscape Ordinance (MWELO) estimates effective precipitation as 25% of total annual rainfall.
- 7.2 When using an irrigation system, it is necessary to apply more water than required by plants to make up for irrigation system inefficiencies. Two different metrics are commonly used to estimate how much additional water to apply to account for irrigation system inefficiencies.
- **Irrigation efficiency (IE)** is a metric that reflects the amount of water that is beneficially used by plants compared to the amount of water that is applied by an irrigation system.
 - IE is usually expressed as a percentage, where 100% is perfect efficiency.
 - IE reflects factors such as water management, runoff, evaporation, leakage, and wind spray.
 - **Distribution uniformity (DU)** is a different metric that provides a measurement of how evenly water is applied to a hydrozone.
 - DU is a value between zero and 1.0, where 1.0 represents perfect uniformity.
 - DU is more easily measured than IE.
 - Some water budgets use IE and others use DU.
 - The concepts of IE and DU are covered in detail in Section 7, Irrigation System Auditing.
- 7.3 The calculation of the amount of irrigation water to apply in gallons subtracts effective precipitation (EP) from the basic water budget in 6.1 and accounts for irrigation system inefficiencies (IE).

Irrigation Water = [(Weather x Plant Type) – Rain] x Area ÷ Efficiency

Irrigation Water = [(ETo x PF) – EP] x LA ÷ IE x 0.62

7.4 Irrigation water requirement examples.

- 1,000 sq ft landscape area, PF of 0.8, peak monthly ETo of 6 inches, EP of 0 inches and IE of 0.7
Irrigation Water = $[(6 \times 0.8) - 0] \times 1,000 \div 0.7 \times 0.62 = 4,251$ gallons
- 1,000 sq ft landscape area, PF of 0.8, peak monthly ETo of 6 inches, EP of 1 inch and IE of 0.7
Irrigation Water = $[(6 \times 0.8) - 1] \times 1,000 \div 0.7 \times 0.62 = 3,366$ gallons
- 1,000 sq ft landscape area, PF of 0.8, peak monthly ETo of 6 inches, EP of 1 inch and IE of 0.6
Irrigation Water = $[(6 \times 0.8) - 1] \times 1,000 \div 0.6 \times 0.62 = 3,927$ gallons

8 WATER BUDGET CHALLENGES

8.1 ETo must be known.

- Not all areas have reliable ETo data.
- Current ETo data is preferred to historical averages.

8.2 Determining the PF may not be straightforward in practice.

- New landscapes should have a planting plan that identifies plant species.
- Existing landscapes rely on the knowledge, experience, and observations of the water manager.
- There are differences of opinion on appropriate PFs depending on the source used, and related to factors such as microclimate and planting density.

8.3 The irrigated landscape area must be known or measured.

- New landscapes should have plans that provide measurements.
- Existing landscapes will require measurement.
- Exclude hardscapes and unirrigated areas from measurements.
- Effective measurement methods include:
 - Aerial imagery such as Google Maps or local GIS tools.
 - Tape measure.
 - Measuring wheel.
 - Pace (assuming you know the distance of your pace).
- Visual estimation of measurements is not an effective method.
- Basic geometry can be useful in estimating landscape areas.
 - Square or rectangle = width x length
 - Triangle = $\frac{1}{2}$ x base x height
 - Circle = $3.14 \times \text{radius}^2$
- Irregular areas must be estimated (estimation tips/methods/examples described below).
 - Divide area into smaller areas with even shapes and add them together.
 - Measure as a circle where the radius is the average of 16 readings. This method requires a board with 16 lines drawn at 22.5 degree angles from the center point. Place the board in the center of the area and measure to the edge along each of the 16 lines. Calculate the average radius and then use the formula for a circle to calculate the area.⁶

⁶ <https://youtu.be/Rogg7stSj6c>

9 EXAMPLES OF WATER BUDGETS

- 9.1 Water budgets are frequently used to provide a [water allowance](#) which is then compared to the [water requirement](#) for the landscape. Irrigating a landscape to a water budget requires the water manager to take regular water meter readings to ensure that the amount of water applied does not exceed the budget.
- 9.2 EPA WaterSense labeled new homes must use the [WaterSense Water Budget Tool](#)⁷ to design a landscape based on a regionally appropriate amount of water.
- The WaterSense Water Budget Tool determines the landscape water allowance (LWA) and compares it to the landscape water requirement (LWR) to determine if the landscape meets the available water budget.
 - The landscape water allowance is equivalent to a plant factor of 0.7.
 - ETo used is the peak month as per the Water Budget Data Finder⁸ and may differ from locally available data.
- 9.3 **California:** The California Department of Water Resources [Model Water Efficient Landscape Ordinance](#)⁹ (MWELO) uses a water budget approach for new landscape projects of 500 square feet or more, and rehabilitated landscape projects of 2,500 square feet or more that require a building or landscape permit, plan check, or design review.
- MWELO applications must determine the maximum applied water allowance (MAWA) and compare it to the estimated total water use (ETWU). ETWU must be below the MAWA for the proposed landscape to comply with MWELO.
 - MAWA is calculated based on an evapotranspiration adjustment factor (ETAF) of 0.55 for residential areas and 0.45 for non-residential areas. The ETAF combines the plant factor and the irrigation efficiency and is used to adjust ETo.
- 9.4 The University of California, Division of Agriculture and Natural Resources Center for Landscape & Urban Horticulture,¹⁰ developed the [Simplified Landscape Irrigation Demand Estimation \(SLIDE\)](#) method for estimating water demand of [established landscapes](#).
- The SLIDE method is used as a basis for the ANSI/ASABE S623 Standard, Determining Landscape Plant Water Demands.
 - The basic formulas of SLIDE are consistent with those presented in the water budget calculations 6 and 7, above. The major difference is the simplified set of plant factors used as an alternative to a large database of plant species.

⁷ <https://www.epa.gov/watersense/water-budget-tool>

⁸ <https://www.epa.gov/watersense/water-budget-data-finder>

⁹ <http://www.water.ca.gov/wateruseefficiency/landscapeordinance/>

¹⁰ <https://ucanr.edu/sites/UrbanHort/>

Table 4-5: SLIDE plant factors for established landscape plants

Plant Type	Plant Factor
Tree, Shrubs, Vines, Groundcovers (woody plants)	0.5
Herbaceous Perennials	0.5
Desert Adapted Plants	0.3
Annual Flowers & Bedding Plants	0.8
General Turfgrass Lawns, cool-season (tall fescue, Ky. bluegrass, rye, bent)	0.8
General Turfgrass Lawns, warm-season (bermuda, zoysia, St, Augustine, buffalo)	0.6
Home Fruit Crops, Deciduous	0.8
Home Fruit Crops, Evergreen	1.0
Home Vegetable Crops	1.0
Mixed Plantings	PF of the planting is that of the plant type present with the highest PF

- 9.5 California: The [CLCA Water Management Certification Program](#)¹¹ is an EPA WaterSense labeled program in irrigation systems auditing, targeted at practicing water managers that uses performance based water budgets.
- Certified water managers must successfully manage properties at or below the landscape water budget established by the CLCA Water Management Performance Program or local agency.
 - The Landscape Water Budget standards for CLCA’s Water Management Certification are in compliance with the standards set by the Model Water Efficient Landscape Ordinance.
 - The CLCA water budget plant factor and distribution uniformity assumptions are shown in Table 4-6:
 - Effective rainfall is described as 30 percent of the precipitation in any month having more than one inch (1-inch) of total precipitation. Effective rainfall is capped at 100% of reference evapotranspiration (ET_o) for the month.

Table 4-6: CLCA crop coefficient and irrigation distribution uniformity

Plant Factor	Irrigation Distribution Uniformity
Cool Season Turf: 0.8	Spray: 0.55
Annual Color: 0.8	Impact Heads: 0.5
Warm Season Turf: 0.6	Large Rotors: 0.6
Ground Cover / Shrubs: 0.6	Small Rotors: 0.5
Shrubs (no ground cover): 0.5	Drip: 0.7
Drought-tolerant Plant: 0.3	
Native Plant: 0.3	

¹¹ <http://clca.org/water-pro>

10 LANDSCAPE WATER REVIEW QUESTIONS

- 10.1 What is a landscape water budget and what are the three elements of a basic landscape water budget?
- 10.2 True or false: ET changes as the weather changes and is affected by factors including solar radiation, air temperature, relative humidity, and wind speed?
- 10.3 What does ETo stand for?
- 10.4 The plant factor is expressed as a percentage of ____.
- 10.5 Name a few identifying characteristics of low water use plants.
- 10.6 What is a hydrozone?
- 10.7 How do you calculate a basic landscape water budget using ETo, the plant factor (PF), and the landscape area (LA)?
- 10.8 What's the difference between the basic landscape water budget and the amount of irrigation water to apply?
- 10.9 California focus: What does CIMIS stand for?
- 10.10 California focus: What is the peak irrigation month for most climate zones in California?
- 10.11 California focus: What does WUCOLS stand for?

Section 5:
**IRRIGATION
SYSTEMS**





IRRIGATION SYSTEMS

Learning Objectives

1. Know how to determine static and operating water pressure
2. Understand the effect of elevation change on an irrigation system
3. Understand how to use manufacturer catalogs
4. Be familiar with irrigation system components and their functions
5. Be familiar with application devices and application rates

1 STATIC AND OPERATING WATER PRESSURE

1.1 It is important to have an understanding of water system pressure, as it has a significant impact on irrigation system performance.

- The irrigation auditor measures pressure throughout the irrigation system to validate system testing and to check for variations in pressure within irrigation zones.
- Water system demands change throughout the day and night, which can result in changes in system pressure.

1.2 Static and operating pressure

- Water pressure is measured in **pounds per square inch (PSI)**.
- **Static pressure** is defined as the pressure of water in a pressurized line, and is determined using a pressure gauge when water is **not running** through the system (Figure 5-1).
- **Operating pressure** (dynamic pressure) is defined as the measurement of pressure in a line **as water flows** through the line, and is determined using a pressure gauge when water is running.

Figure 5-1: Toro flow and pressure gauge (image courtesy of The Toro Company)



1.3 Pressure and flow relationship

- Flow is measured in **gallons per minute (GPM)** or **gallons per hour (GPH)** for low volume irrigation.
- Water pressure decreases as water travels through the irrigation system due to the friction of water against pipe walls as well as through components and fitting.
 - This is referred to as friction loss.
- The **larger the pipe diameter the lower the pressure** needed to deliver a quantity (flow) of water. In other words, larger pipes can deliver a greater volume of water with less pressure.
- The **smaller the pipe diameter the greater the pressure loss** due to friction against the pipe surface, components, and fittings (e.g. given the same flow rate, a $\frac{3}{4}$ -inch schedule 40 PVC pipe will have more pressure loss than a $1\frac{1}{2}$ -inch schedule 40 PVC pipe).
- The accepted industry standard for maximum safe flow velocity in plastic irrigation pipe systems is **5 feet per second (FPS)**. This is typically indicated on a friction loss chart by shaded areas where the velocity exceeds 5 FPS.
 - Velocity is the speed at which the water travels through the irrigation piping.
 - As flow increases, velocity also increases within a given pipe size.
- Irrigation manufacturers publish friction loss charts for different types of pipe. An example friction loss chart for schedule 40 PVC is included in Figure 5-2.
 - IPS stands for Iron Pipe Size and is the pipe sizing standard commonly used by PVC pipe manufacturers. Using this standard ensures that different types of PVC of a given size have the same outside diameter.

1.4 **Polyvinyl chloride (PVC)** piping is commonly used in irrigation systems.

- PVC pipe should not be left exposed to sunlight for more than a few months. The PVC breaks down when exposed to light and will weaken over time. If PVC pipe is above ground:
 - Paint the pipe with several coats of paint, or

Figure 5-2: Friction loss chart for schedule 40 PVC (image courtesy of Hunter Industries Inc)

FRICITION LOSS CHARACTERISTICS PVC SCHEDULE 40 IPS PLASTIC PIPE (1120, 1220) C = 150 PSI loss of 100 feet of tube (PSI/100 FT) Sizes 1/2" thru 6" Flow GPM 1 thru 600													
SIZE	1/2"		3/4"		1"		1 1/4"		1 1/2"		2"		
OD	0.840		1.050		1.315		1.660		1.900		2.375		
ID	0.622		0.824		1.049		1.360		1.610		2.067		
WALL THK	0.109		0.113		0.133		0.140		0.145		0.154		
FLOW GPM	VELOCITY FPS	P.S.L. LOSS	VELOCITY FPS	P.S.L. LOSS	VELOCITY FPS	P.S.L. LOSS	VELOCITY FPS	P.S.L. LOSS	VELOCITY FPS	P.S.L. LOSS	VELOCITY FPS	P.S.L. LOSS	
1	1.05	0.43	0.60	0.11	0.37	0.03	0.21	0.01	0.15	0.00			
2	2.11	1.55	1.20	0.39	0.74	0.12	0.42	0.03	0.31	0.02	0.19	0.00	
3	3.16	3.28	1.80	0.84	1.11	0.26	0.64	0.07	0.47	0.03	0.28	0.01	
4	4.22	5.60	2.40	1.42	1.48	0.44	0.85	0.12	0.62	0.05	0.38	0.02	
5	5.27	8.46	3.00	2.15	1.85	0.66	1.07	0.18	0.78	0.08	0.47	0.02	
6	6.33	11.86	3.60	3.02	2.22	0.93	1.28	0.25	0.94	0.12	0.57	0.03	
7	7.38	15.77	4.20	4.01	2.59	1.24	1.49	0.33	1.10	0.15	0.66	0.05	
8	8.44	20.20	4.80	5.14	2.96	1.59	1.71	0.42	1.25	0.20	0.76	0.06	
9	9.49	25.12	5.40	6.39	3.33	1.97	1.92	0.52	1.41	0.25	0.85	0.07	
10	10.55	30.54	6.00	7.77	3.70	2.40	2.14	0.63	1.57	0.30	0.95	0.09	
11	11.60	36.43	6.60	9.27	4.07	2.86	2.35	0.75	1.73	0.36	1.05	0.11	
12	12.65	42.80	7.21	10.89	4.44	3.36	2.57	0.89	1.88	0.42	1.14	0.12	
14	14.76	56.94	8.41	14.48	5.19	4.47	2.99	1.18	2.20	0.56	1.33	0.17	
16	16.87	72.92	9.61	18.55	5.93	5.73	3.42	1.51	2.51	0.71	1.52	0.21	
18	18.98	90.69	10.81	23.07	6.67	7.13	3.85	1.88	2.83	0.89	1.71	0.26	
20	21.09	110.23	12.01	28.04	7.41	8.66	4.28	2.28	3.14	1.08	1.90	0.32	
22			13.21	33.45	8.15	10.33	4.71	2.72	3.46	1.29	2.10	0.38	
24			14.42	39.30	8.89	12.14	5.14	3.20	3.77	1.51	2.29	0.45	
26			15.62	45.58	9.64	14.08	5.57	3.17	4.09	1.75	2.48	0.52	
28			16.82	52.28	10.38	16.15	5.99	4.25	4.40	2.01	2.67	0.60	
30			18.02	59.41	11.12	18.35	6.42	4.83	4.72	2.28	2.86	0.68	
35					12.97	24.42	7.49	6.43	5.50	3.04	3.34	0.90	
40					14.83	31.27	8.56	8.23	6.29	3.89	3.81	1.15	
45					16.68	38.89	9.64	10.24	7.08	4.84	4.29	1.43	
50					18.53	47.27	10.71	12.45	7.87	5.88	4.77	1.74	

How to Read the Friction Loss Chart

- Select pipe size at the top of the chart.
- Each pipe size has two columns:
 - Velocity
 - PSI Loss
- Select flow rate on the left side of the table.
- Find the pressure loss value that corresponds to the two readings.
- For example, the pressure loss for 1-inch schedule 40 PVC with a flow rate of 10 GPM is 2.40 PSI per 100 foot of pipe.
- Ensure velocity is outside of shaded area (< 5 FPS).

- Wrap the pipe with aluminum foil or pipe insulation held securely in place, or
- Build a wood or metal box to go over the pipe to keep out sunlight. This is also a good way to hide the valves and protect them from vandalism.
- Color
 - White, gray, or blue PVC is used for potable water.
 - Purple PVC pipe is used for non-potable water, typically recycled water.
- Type
 - Schedule 80 pipe is usually dark gray (although it can be white) and has thicker walls than schedule 40, which results in a narrower inside diameter for a given outside diameter, and is rated for higher pressures. The narrower inside diameter means that schedule 80 pipe has a more restricted flow.
 - Schedule 80 PVC is often used for risers.
 - Schedule 40 PVC pipe is usually white and can be used for mainlines (typically up to 1 1/2-inches) and is commonly used for lateral lines.
 - Class 200 small diameter PVC should not be used due to the thin walls and potential of

breakage.

- Class 315 PVC is white, and may be seen used on mainlines 2-inches and larger.
- Pressure rating (Figure 5-3)
 - As the pipe size of schedule 40 and schedule 80 increases, the strength and pressure rating decrease.
 - Class 200 and class 315 PVC pipe have a constant pressure rating, 200 psi and 315 psi, respectively.
 - Class 315 exceeds the pressure rating of schedule 40 at 2-inches

Figure 5-3: PVC pipe pressure rating

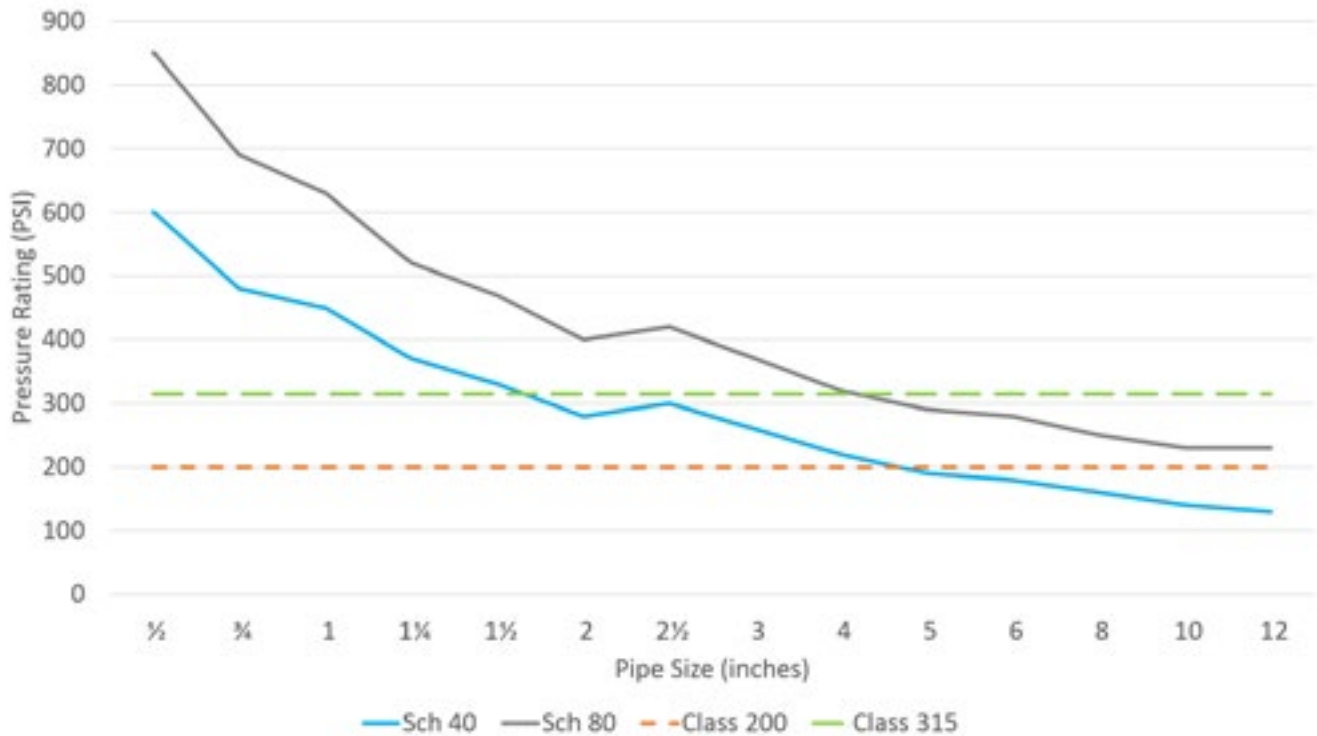

2 EFFECT OF ELEVATION CHANGE

2.1 The relationship between pressure and elevation is referred to as **feet of head**.

2.2 Water moving up hill in a pipe loses pressure while water moving down hill gains pressure (Figure 5-4).

- Water moving downhill from point A to point B will gain **0.433 psi per 1 foot** of elevation change. Conversely, water moving uphill from point B to point A will lose 0.433 psi per 1 foot of elevation change
- Another way to visualize this is that every **2.31 ft** of elevation change will result in a **1 psi** change in pressure.

Figure 5-4: Effect of elevation change

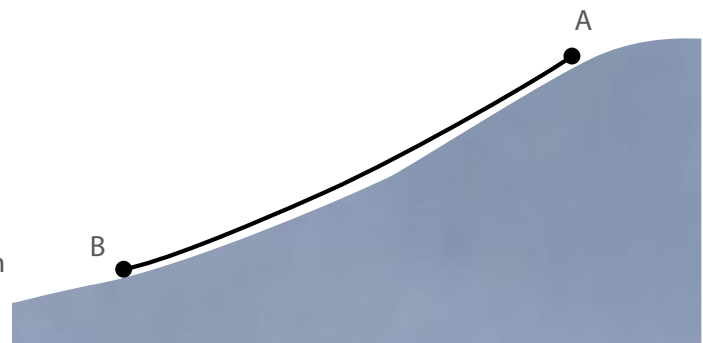





2.3 A rough figure of 0.5 psi per foot of head is often used as an approximation.

3 MANUFACTURER CATALOGS

- 3.1 Use [pipe friction loss charts](#) to determine pressure loss for a given flow rate (measured in GPM) through a given size pipe.
- 3.2 Use [nozzle performance charts](#) (Figure 5-5) to identify sprinkler nozzles, operating pressures, radii of throw, flow rates, and precipitation rates.
 - Precipitation rate is the application rate measured in inches per hour. Further detail is provide in Section 7 Irrigation System Auditing.
- 3.3 Take care in choosing nozzle types and brands when installing or repairing an irrigation system, as they will typically have [different application rates](#).

Figure 5-5: Example MP Rotator performance data (image courtesy of Hunter Industries Inc)

MP ROTATOR PERFORMANCE DATA																
Arc	Pressure PSI	MP1000 Radius: 8' to 15' Adjustable Arc and Full-Circle					MP2000 Radius: 17' to 21' Adjustable Arc and Full-Circle					MP3000 Radius: 22' to 30' Adjustable Arc and Full-Circle				
		Radius ft.	Flow GPM	Flow GPH	Precip in/hr ■ ▲	Radius ft.	Flow GPM	Flow GPH	Precip in/hr ■ ▲	Radius ft.	Flow GPM	Flow GPH	Precip in/hr ■ ▲			
90° 	25	--	--	--	--	17	0.34	20.4	0.45	0.52	25	0.71	42.6	0.44	0.51	
	30	12	0.17	10.2	0.45	0.52	18	0.38	22.8	0.45	0.52	27	0.76	45.6	0.40	0.46
	35	13	0.19	11.4	0.43	0.50	19	0.40	24.0	0.43	0.49	28	0.82	49.2	0.40	0.46
	40	14	0.21	12.6	0.41	0.48	20	0.43	25.8	0.41	0.48	30	0.86	51.6	0.37	0.42
	45	14	0.23	13.8	0.45	0.52	21	0.46	27.6	0.40	0.46	30	0.90	54.0	0.39	0.44
	50	15	0.25	15.0	0.43	0.49	21	0.47	28.2	0.41	0.47	30	0.95	57.0	0.41	0.47
180° 	25	--	--	--	--	16	0.6	36.0	0.45	0.52	25	1.44	86.4	0.44	0.51	
	30	12	0.34	20.4	0.45	0.52	17	0.64	38.4	0.43	0.49	27	1.58	94.8	0.42	0.48
	35	13	0.38	22.8	0.43	0.50	18	0.71	42.6	0.42	0.49	28	1.70	102.0	0.42	0.48
	40	14	0.42	25.2	0.41	0.48	19	0.77	46.2	0.41	0.47	30	1.82	109.2	0.39	0.45
	45	14	0.44	26.4	0.43	0.50	20	0.85	51.0	0.41	0.47	30	1.93	115.8	0.41	0.48
	50	15	0.50	30.0	0.43	0.49	21	0.91	54.6	0.40	0.46	30	2.04	122.4	0.44	0.50
210° 	25	--	--	--	--	16	0.72	43.2	0.46	0.54	25	1.68	100.8	0.44	0.51	
	30	12	0.40	24.0	0.46	0.53	17	0.75	45.0	0.43	0.49	27	1.84	110.4	0.42	0.48
	35	13	0.45	27.0	0.44	0.51	18	0.81	48.6	0.41	0.48	28	1.99	119.4	0.42	0.48
	40	14	0.49	29.4	0.41	0.48	19	0.86	51.6	0.39	0.45	30	2.12	127.2	0.39	0.45
	45	14	0.51	30.6	0.43	0.50	20	0.91	54.6	0.38	0.43	30	2.25	135.0	0.41	0.48
	50	15	0.57	34.2	0.42	0.48	21	0.98	58.8	0.37	0.42	30	2.37	142.2	0.43	0.50
270° 	25	--	--	--	--	16	0.87	52.2	0.44	0.50	25	2.19	131.4	0.45	0.52	
	30	12	0.48	28.8	0.43	0.49	17	0.95	57.0	0.42	0.49	27	2.37	142.2	0.42	0.48
	35	13	0.53	31.8	0.40	0.46	18	1.03	61.8	0.41	0.47	28	2.55	153.0	0.42	0.48
	40	14	0.63	37.8	0.41	0.48	19	1.10	66.0	0.39	0.45	30	2.73	163.8	0.39	0.45
	45	14	0.67	40.2	0.44	0.51	20	1.17	70.2	0.38	0.43	30	2.89	173.4	0.41	0.48
	50	15	0.72	43.2	0.41	0.47	21	1.23	73.8	0.36	0.41	30	3.06	183.6	0.44	0.50
360° 	25	--	--	--	--	16	1.20	72.0	0.45	0.52	25	2.88	172.8	0.44	0.51	
	30	12	0.69	41.4	0.46	0.53	17	1.28	76.8	0.43	0.49	27	3.15	189.0	0.42	0.48
	35	13	0.77	46.2	0.44	0.51	18	1.37	82.2	0.41	0.47	28	3.40	204.0	0.42	0.48
	40	14	0.84	50.4	0.41	0.48	19	1.48	88.8	0.39	0.46	30	3.64	218.4	0.39	0.45
	45	14	0.88	52.8	0.43	0.50	20	1.57	94.2	0.38	0.44	30	3.86	231.6	0.41	0.48
	50	15	0.98	58.8	0.42	0.48	21	1.68	100.8	0.37	0.42	30	4.07	244.2	0.44	0.50
55	15	1.01	60.6	0.43	0.50	21	1.74	104.4	0.38	0.44	30	4.27	256.2	0.46	0.53	

4 IRRIGATION SYSTEM COMPONENTS

4.1 Figure 5-6 provides an overview of an irrigation system, using generic terms as well as Hunter Industries product names.

Figure 5-6: Irrigation system overview (image courtesy of Hunter Industries Inc)

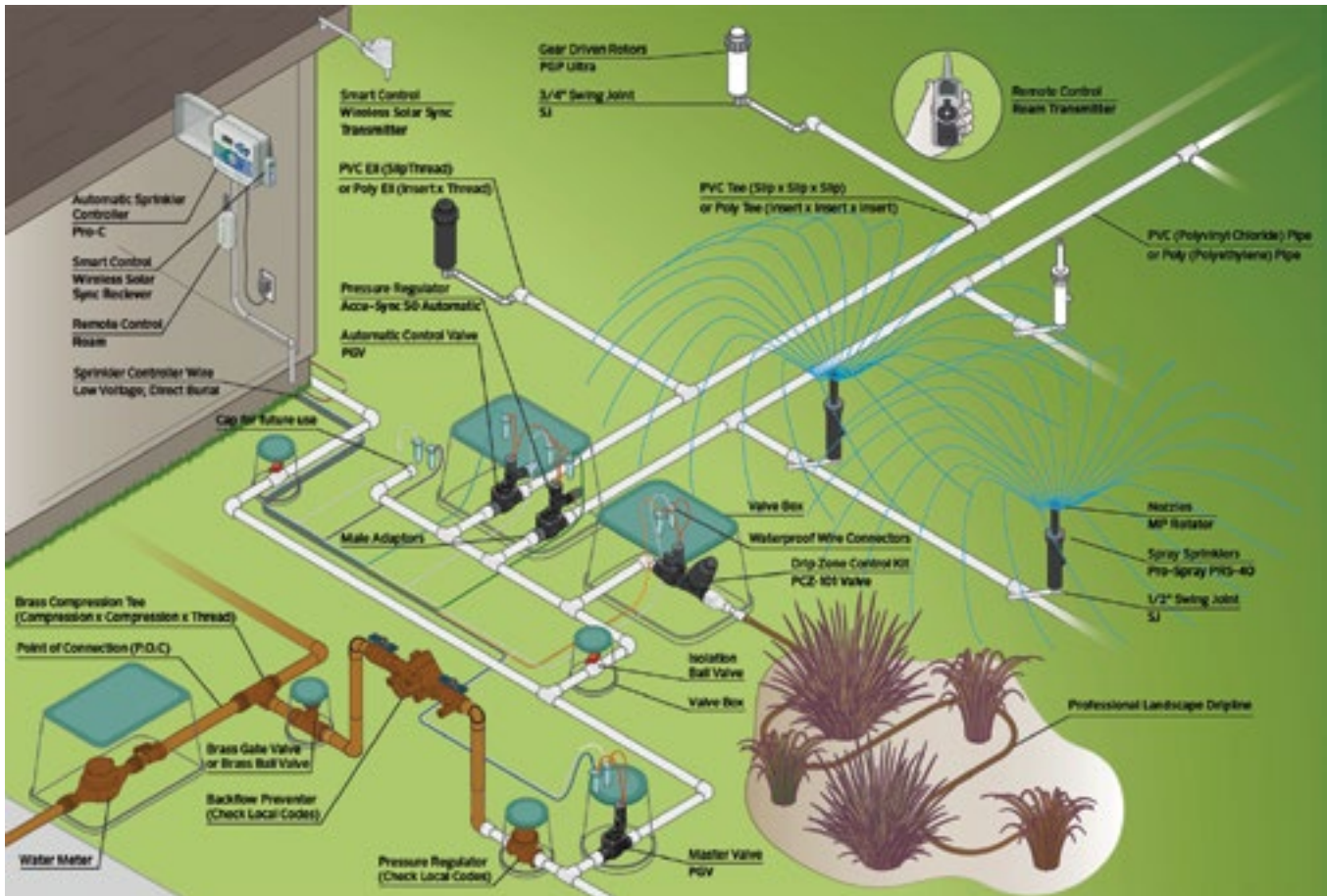

4.2 **As-built plans** should be created during or soon after installation and reflect the system configuration as it was actually installed.

- The actual location of some irrigation system components often differs from their location on an irrigation plan.
- Having a record of the irrigation system “as-built” is extremely helpful for maintenance and repairs in the future, and can save significant amounts of time and money.
- This is especially true for mulched landscapes where in-ground components can be difficult to locate over time.
- Maintenance contractors should use these plans to record and map irrigation system components, hydrozone boundaries, and to identify when and where repairs are undertaken.
- It is recommended to color code each hydrozone.

4.3 A **water meter** (Figure 5-7) allows for measurement of water being used and is an important tool for leak detection and determining the flow rate of an irrigation zone.

Figure 5-7: Water meter



- 4.4 The **point of connection** (POC) is where the irrigation mainline is joined to the water service line.
- 4.5 **Backflow devices** (Figure 5-8) ensure water quality by preventing contamination of the potable (drinking) water supply due to back-pressure or back-siphonage of irrigation water into the municipal system.
- This is important for irrigation systems due to potential contamination from fertilizers, pesticides, and herbicides.
 - Local regulations vary as to acceptable backflow standards; check with local officials to determine correct devices and configuration in your area.
 - Backflow preventer devices must be inspected annually by a certified backflow inspector.
 - Reduced pressure (RP) backflow devices.
 - The RP valve is the **most reliable** backflow prevention device and can protect against both back-pressure and back-siphonage.
 - **Above-ground installation** is required with a concrete pad and a minimum 12-inch gap between the relief valve and finished grade to allow the RP to discharge water when a back-siphon situation occurs.
 - Double check valves were commonly used for backflow prevention prior to RP devices becoming the standard.
 - Because double check valves do not discharge, they cannot protect against high hazard situations and may not be permitted for use in landscapes by some municipalities.
 - Atmospheric vacuum breaker (AVB).
 - One AVB is installed per valve.
 - AVBs are not designed to be under continuous pressure.
 - To operate effectively, AVB must be located at least 12-inches above the highest outlet point on the system.
 - Anti-siphon valve (ASV) is a control valve with a built-in AVB.
 - The most common type of backflow preventer used on residential systems.
 - Pressure vacuum breaker (old technology not approved for new construction).
 - Similar to AVB but installed on mainline leading to control valves, as it is designed to be under constant pressure.

Figure 5-8: Left to right (1) RP double check valve, (2) double check valve, (3) atmospheric vacuum breaker (images courtesy of Watts)



- 4.6 The **irrigation mainline** supplies water from the point of connection (POC) to the control valves and is under constant pressure unless the water meter or backflow device is shut off.

4.7 A **pressure regulator** (Figure 5-9) regulates high inlet water pressure to reduce outlet water pressure. This can improve the performance and longevity of the irrigation system components if the inlet water pressure is too high. These devices should be checked periodically to ensure proper function.

Figure 5-9: Pressure regulator (image courtesy of Zurn)



4.8 **Mainline isolation valves** (Figure 5-9) are used to shut off (isolate) a section of pressurized irrigation mainline, allowing for repairs to be performed without shutting off water to the entire irrigation system.

- Gate valves open and close gradually, reducing water hammer. Extra care should be taken to open gate valves slowly on large lines to further protect them.
- Ball valves may be opened and closed with a ¼ turn of the handle. Generally, ball valves are less prone to leak over time than gate valves.
 - Ball valves should be operated slowly to prevent damage to system components and fittings.

4.9 **Manifold isolation (shut-off) valves** (Figure 5-10) shut off irrigation water to individual irrigation manifolds, allowing the valves to be repaired without shutting down the entire irrigation system, or the indoor water supply for a mixed use meter. The shut-off valve should be positioned before (upstream from) the irrigation valves.

Figure 5-10: Left to right (1) brass gate valve, (2) brass ball valve, (3) PVC ball valve (images courtesy of Nibco)



1



2



3

4.10 **Electric irrigation valves** (Figure 5-11), also called remote control valves (RCV), are used in conjunction with an irrigation controller to turn water on and off and actuate the various zones of the irrigation system.

- A **manifold** is a grouping of irrigation valves.
- Locate valves close to sidewalks or hardscape and the area to be irrigated. This helps to identify valve locations and improves ease of servicing them.
 - Exceptions to this might be in locations where the visual presence of valve boxes is not acceptable, or where they are likely to be vandalized.
- Do not hide valves beneath plants.
- Valves open when an electrical signal from the controller energizes an electromagnet (**solenoid**) that allows the valve to open.
- Most electric irrigation valves are **normally closed** and require an electric signal to allow the flow of water. Some valves are **normally open** (rare) and require an electric signal to stop the flow of water.
- Since most irrigation controllers run on AC power, **24-volt AC solenoids** are the most common type of solenoid. These solenoids are designed to have power to them throughout the irrigation cycle.

- Battery or solar powered controllers require **DC latching solenoids**. These solenoids are designed to conserve energy by only requiring power when actuating (opening or closing) the zone.
- A master valve is most often a normally closed valve that is installed prior to (upstream of) all other electric irrigation valves. It opens when any valve connected to the same controller is activated.
 - A **master valve** is used to prevent any malfunctioning valves in the system from wasting water after the system is off and to prevent the likelihood of water loss from pipe breaks outside of the irrigation window.
 - A normally closed master valve provides protection from system water loss during non-irrigation hours.
 - Some master valves are normally open where constant system pressure is required, such as for use with quick coupler valves (a subsurface valve that utilizes a key and attachments to access water), when used in conjunction with a flow sensor.
 - Depending on the specification of the irrigation controller, both normally open and normally closed master valves can be used in conjunction with a flow sensor to shut down the irrigation system and send alerts to the water manager in the event of a pipe rupture or valve malfunction.
- For drip irrigation valves it is recommended that they are used in conjunction with proper **pressure regulation** and **filtration** devices for the system to operate at optimal performance.
- An in-ground valve is an electric RCV located and installed in an underground valve box.
 - Must be connected to a mainline that has a backflow prevention device.
 - Industry standard installation is parallel to and spaced 18-inches from hardscapes with a 12-inch separation between each in-ground valve.
- **Above-ground** electric atmospheric breaker valves (anti-siphon).
 - Must be installed **higher** than the highest point of water in the pipe and emission devices it serves in order for the built-in backflow preventer to function properly. Refer to local code specifications for minimum height, typically 12 to 18-inches.

Figure 5-11: Left to right (1) irrigation valve cutaway, (2) globe irrigation valve, (3) anti-siphon irrigation valve with pressure regulating filter (images courtesy of Rain Bird Corporation)



4.11 Irrigation wiring from the irrigation controller to the valve.

- **110 volt** is the standard line voltage for electrical outlets and is used to power irrigation controllers. Irrigation controllers use a transformer to step-down to **24 volts** for the valve wiring that energizes irrigation valves.
- The valve wiring goes between the irrigation controller and the irrigation valves, and is often located adjacent to or under the irrigation mainline, sharing a common trench. In some instances, it is housed in electrical conduit for protection and to allow for additional wire(s) to be installed at a future date if needed.
- Common wire gauge sizes for irrigation valves are 18-gauge multi-conductor for residential and short distance runs.
- Commercial sites typically use larger 12-14-gauge single-conductor wire. Choosing the correct wire size depends on multiple factors including: Transformer output, minimum valve voltage, valve PSI, total amps drawn, length of wire run, number of valves running at one time (including master valve) and allowable voltage loss.
 - Consult with a licensed electrician if necessary.
- **Conventional wiring** uses one common wire and a hot wire for each irrigation valve.
 - The common wire is typically white.
- **Two-wire** uses only two wires combined with a decoder. Two-wire systems are used for large commercial and residential systems or phased installations where the cost savings in wire and other advantages can be significant.

4.12 **Irrigation controllers** (Figure 5-12) are devices that control the operation of electric irrigation valves and the delivery of water to the landscape. This is the 'brain' of the irrigation system. Controllers can be used to efficiently manage the application of irrigation water, but if not managed and programmed properly, can be a major source of water waste in the landscape.

- **Conventional stand-alone controllers** are programmed with fixed schedules.
- Weather-based irrigation controllers (WBICs), commonly referred to as smart controllers, use local weather, landscape conditions, and type of irrigation equipment to tailor watering schedules to actual conditions on the site. Some conventional controllers can be upgraded to WBICs with the addition of a module and/or sensor.

Figure 5-12: Left to right (1) Hunter Pro-C, (2) Irritrol Rain Dial-R, (3) Rain Bird SST, (4) Toro Evolution (images courtesy of Hunter Industries Inc, Irritrol, Rain Bird Corporation, and The Toro Company)



- EPA WaterSense provides a list of [WaterSense labeled irrigation controllers](#).¹ These WBICs have been independently certified to ensure that they can adequately meet the watering needs of a landscape without overwatering.
- [Smart Water Application Technologies \(SWAT\)](#)² is a coalition of water purveyors, equipment manufacturers, and irrigation practitioners that develops testing protocols and promotes water-efficient products, including WBICs.
- Irrigation controllers are covered in detail Section 9, Irrigation Controllers.



4.13 **Sensors** (Figure 5-13) for irrigation controllers are devices that interrupt the electrical signal in response to specific site conditions and modify the operation of the irrigation controller.

- Sensors are covered in detail in Section 9, Irrigation Controllers.
- **ET** sensors can upgrade a standard controller to a WBIC.
- **Flow** sensors shut down the irrigation system when a specified level of overflow or underflow has occurred.
- **Soil moisture** sensors measure soil moisture within the root zone, and can be programmed to shut down the irrigation controller when the desired soil moisture level has been reached.
- **Rain** sensors shut down the irrigation controller during periods of measurable rainfall.
- **Wind** sensors shut down the irrigation controller during periods of high wind.
- **Freeze** sensors prevent the irrigation system from operating in freezing temperatures.

Figure 5-13: Left to right (1) Hunter Solar Sync, (2) Irritrol Climate Logic, (3) Rain Bird WR2 Rain/Freeze Sensor, (4) Toro Precision Soil Sensor, (5) Hunter Flow Sensor (images courtesy of Hunter Industries In, Irritrol, Rain Bird Corporation, and The Toro Company)



¹ <https://www.epa.gov/watersense/irrigation-controllers>

² <https://www.irrigation.org/SWAT>

5 APPLICATION DEVICES AND APPLICATION RATES

- 5.1 **Overhead irrigation** devices are used to apply water across the surface through the air. Overhead irrigation is best suited to turf and other low-growing ground covers. When overhead spray is used to irrigate plants that grow taller than the emission device, the spray may become blocked. Most overhead irrigation devices sold today pop up when activated and are flush with the landscape when not in use. Many older irrigation systems have overhead irrigation devices on fixed risers.
- 5.2 **Fixed spray sprinklers** (Figure 5-14) apply a fan of water over a given area.
- Typical radius of throw of 2-17 feet.
 - Typical precipitation rate of 1.5 to 2.0 inches/hour (up to 8 in/hr for shorter throw nozzles).
 - Typically designed to operate at 30 psi.
 - Pop-ups are available in a variety of heights. 6-inch is recommended for turfgrass to avoid the spray being blocked as the grass grows between mowing.
 - Many **spray bodies** are available with built in **check valves** to eliminate **low head drainage** and **pressure regulation** to avoid **misting** from water being sent through the nozzles at too high a pressure. Spray bodies with these features can save significant amounts of water and are recommended.
 - **Nozzles** screw onto the spray body and can be removed for maintenance and repair. Nozzles used should have **matched precipitation rates**, which means that all of the sprinklers operating on a valve will apply water to a given area at the same rate, regardless of the spray pattern.
 - Both **fixed arc nozzles** and **variable arc nozzles (VAN)** are available.
 - High-efficiency nozzles with a fixed spray pattern are also available. Some have larger droplets to reduce wind drift and provide more efficient coverage.

Figure 5-14: Left to right (1) Hunter PRS30, (2) Hunter Pro Fixed Nozzle, (3) Rain Bird 1800 (images courtesy of Hunter Industries Inc and Rain Bird Corporation)



- 5.3 **Rotating sprinklers** (Figure 5-15) apply rotating streams of water over a given area. Rotating sprinklers may also be referred to as multi-stream sprinklers. Compared to spray sprinklers, rotating sprinklers offer more uniform coverage, lower precipitation rates, and can operate at higher pressures without misting or fogging. The larger water droplets put out by rotating sprinklers are less prone to wind drift than fixed spray sprinklers.
- Typical radius of throw of 6-35 feet.
 - Typical precipitation rate of 0.4 to 0.8 in/hr.

Figure 5-15: Left to right (1) Hunter MP Rotator, (2) Rain Bird R-VAN, (3) Toro Precision Series Rotating Nozzle (images courtesy of Hunter Industries Inc, Rain Bird Corporation, and The Toro Company)



- Typically designed to operate at 40 to 55 psi.
- Compatible with same spray bodies as fixed spray sprinkler nozzles. Some manufacturers make spray bodies specifically for rotating sprinkler nozzles, e.g. with pressure regulation at 40 psi rather than 30 psi.

5.4 **Rotors** (Figure 5-16) typically apply a single stream of water that rotates to apply water over a given area. Compared to fixed spray sprinklers rotors have a larger radius of throw, a relatively low precipitation rate, and often require higher water pressure.

- Typical radius of throw 15-100 feet.
- Typical precipitation rate of 0.25 to 1.5 in/hr.
- Typical operating pressure 40 to 110 psi – depending on radius of throw.
- Impact drive sprinklers are a type of rotor. These are commonly seen on older irrigation systems, agricultural systems, and systems applying non-potable water. The uniformity of coverage is not as high as gear-driven rotors.
 - Older worn impact sprinklers can tend to get “stuck” on one end of the rotation
 - Stuck sprinklers will drastically over-water one small area while leaving the rest of the coverage area dry.

Figure 5-16: Left to right (1) Hunter I-40, (2) Rain Bird 5000 Series, (3) Rain Bird AG-5 Maxi-Paw impact (images courtesy of Hunter Industries Inc, and Rain Bird Corporation)



5.5 **Drip** emission devices apply water to a single point or points along a pipe or tube. Drip irrigation is well suited to a variety of landscape applications including trees, shrubs, perennials, groundcovers, and turf, with subsurface application. Compared to overhead irrigation, drip irrigation can achieve a higher uniformity of coverage. When properly installed and operated, drip irrigation provides the opportunity to apply the appropriate amount of water directly to the plant root zone. Since water is applied at or close to ground level, less water is lost due to factors such as evaporation from plant and soil surfaces, runoff caused by overspray, water being blocked by plant material, or wind drift.

- Drip irrigation is often referred to as **point source irrigation**, **low volume irrigation**, or **micro irrigation**.
- While the application rate of individual emitters is typically much lower than overhead emission devices, it can be relatively high for the entire system. For example, a grid of 0.9 gallon per hour (GPH) dripline with 12-inch emitter spacing and 18-inch line spacing has a precipitation rates of 0.98 in/hr.
- There is a plethora of drip irrigation application devices on the market and care should be taken to ensure that all devices on a given zone have the same precipitation rate, e.g. do not mix drip emitters with devices such as bubblers and microsprays on the same valve.
- Drip irrigation systems require **filtration** to prevent debris in the water from clogging the small orifice of emission devices.
- **Pressure regulation** is recommended for emission devices to stay within the manufacturer's recommended working pressure and to perform as specified.

5.6 **Dripline** (Figure 5-17) is polyethylene tubing with embedded emitters inside of the tube spaced evenly at various distances. Dripline is also available installed with fleece wrap or in a mat. The wrap/mat provides additional protection to the tubing for subsurface installations, provides more even dispersion of water, and can supplement the water holding capacity of the soil.

- Emitter flow rates ranging from 0.26 to 1.0 GPH are available.
- Typical emitter spacing of 6, 12, 18 or 24-inch.
- Typical precipitation rate when laid out in a grid (Figure 5-18) of 0.1 to 2.0 in/hr depending on emitter flow rate, emitter spacing, and lateral (row) spacing (Figure 5-19).

Recommended features and practices for most dripline applications:

- Do not mix dripline of different rates or different emitter spacing on the same valve.
- ½ inch diameter tubing is recommended for permanent installations, as it is considerably more durable than ¼ inch tubing and can be installed in longer runs due to lower pressure loss.

Figure 5-17: Dripline (image courtesy of Rain Bird Corporation)



Figure 5-18: Dripline grid layout example

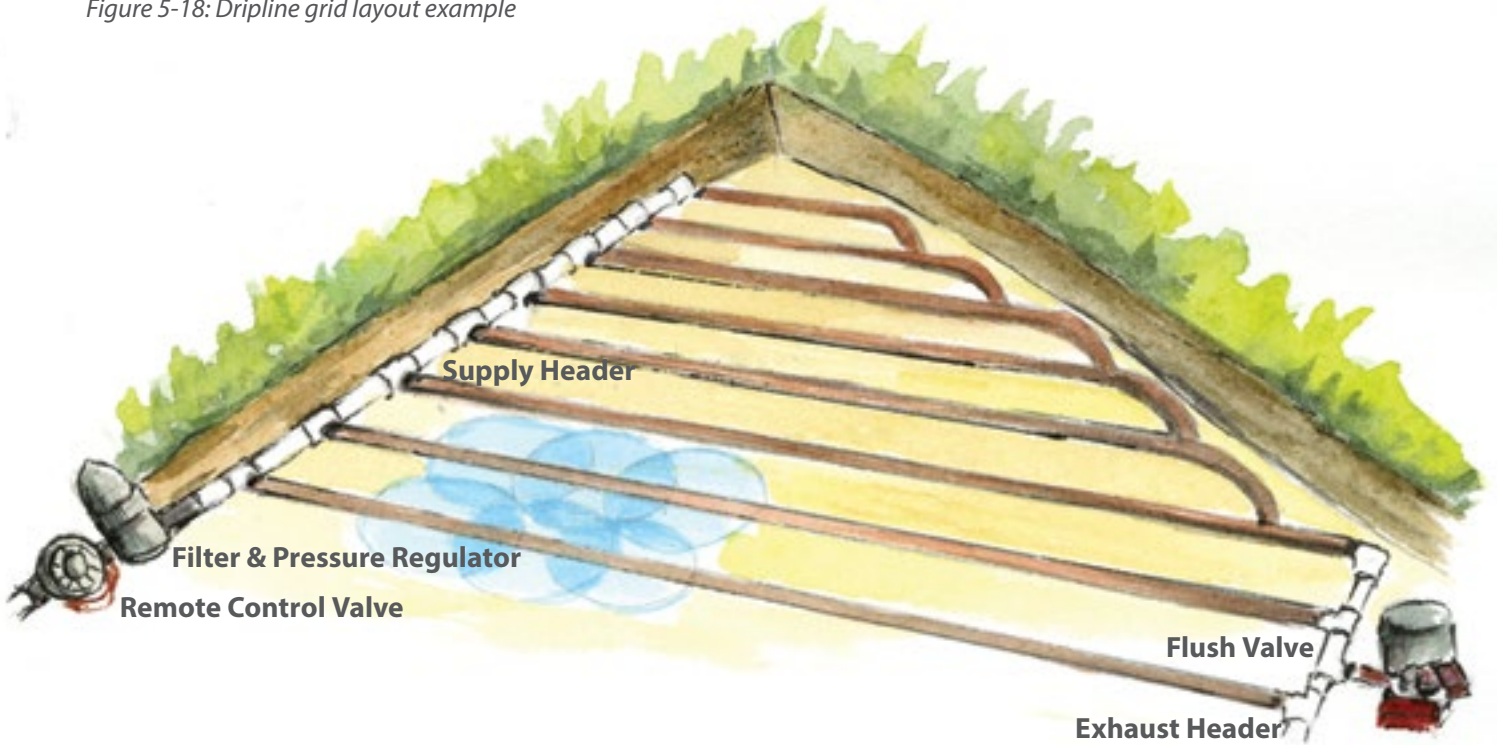

- Emitter spacing and application rate should be matched for soil type and infiltration rate, e.g. clay soils are more suited to lower application rates with a wider spacing.
- Pressure compensating emitters.
- Built-in check valves.
- Layout evenly in a grid with a supply header and an exhaust header for even distribution of water in a tightly spaced planted area. For slopes, dripline should follow contours.
- Follow manufacturers’ recommendations on maximum line run length.
- Design system to maintain adequate pressure throughout the system and to stay within maximum and minimum pressure requirements.
- Include a flush valve (manual or automatic) and an air/vacuum relief valve at the highest point (required if using an automatic flush valve). Check with manufacturer for specific requirements.

Figure 5-19: Netafim Techline CV precipitation rate chart (image courtesy of Netafim USA)

GENERAL GUIDELINES	TURF				SHRUB & GROUNDCOVER																			
	CLAY SOIL		LOAM SOIL		SANDY SOIL		COARSE SOIL		CLAY SOIL		LOAM SOIL		SANDY SOIL		COARSE SOIL									
EMITTER FLOW	0.26 GPH		0.4 GPH		0.6 GPH		0.9 GPH		0.26 GPH		0.4 GPH		0.6 GPH		0.9 GPH									
EMITTER SPACING	18"		12"		12"		12"		18"		18"		12"		12"									
LATERAL (ROW) SPACING	18"	20"	22"	18"	20"	22"	12"	14"	16"	12"	14"	16"	18"	21"	24"	18"	21"	24"	16"	18"	20"	16"	18"	20"
BURIAL DEPTH	Bury evenly throughout the zone from 4" to 6"								On-surface or bury evenly throughout the zone to a maximum of 6"															
APPLICATION RATE (INCHES/HOUR)	0.19	0.17	0.15	0.30	0.27	0.25	0.98	0.84	0.73	1.48	1.27	1.11	0.19	0.16	0.14	0.30	0.26	0.23	0.73	0.65	0.59	1.11	0.99	0.89
TIME TO APPLY ¼" OF WATER (MINUTES)	80	89	97	50	55	61	15	18	20	10	12	13	80	93	106	50	58	66	20	23	26	13	15	17
Following these maximum spacing guidelines, emitter flow selection can be increased if desired by the designer. 0.9 GPH flow rate available for areas requiring higher infiltration rates, such as coarse sandy soils.																								

5.7 **Point-source drip** (Figure 5-20) consists of polyethylene distribution tubing combined with individual emitters that are either connected directly to the distribution tubing, or with ¼ inch spaghetti tube and fittings. There are a variety of emitter designs from different manufacturers including diaphragm, vortex, turbulent-flow, and flag emitters. Different emitter designs use different methods to reduce the water pressure and produce a uniform flow.

- Typical emitter flow rates are ½, 1, 2, 4, and 6 GPH.
- For commercial settings, certain drip emitters can be attached to threaded fittings at the end of ½-inch tubing.

Recommended features and practices for most point-source drip applications:

- Pressure regulation should meet manufacturers' specifications to avoid emitters being blown off of the distribution tubing.
- Protect system components from the sun, e.g. by covering with several inches of mulch. Small plastic fittings become brittle and prone to breaking with prolonged exposure to the sun.
- Do not place emitters at the base of the plant stem or trunk. Emitters should be placed towards the edge of the plant canopy in order to irrigate capillary roots that transfer water into the plant.
- Roots at the base of the plant stem play a lesser role in water uptake and may be susceptible to crown rot.
- Use multiple emitters for each plant appropriate for the plants' mature size and water requirements.
- Use pressure compensating emitters to ensure uniform water application over long tubing runs, and significant elevation changes.
- Emitters with internal check valves are available to hold water in the line when the valve is off.
- Point-source drip emitters and ¼ inch spaghetti tube should be used with great care and consideration in both commercial and residential applications.
 - Individual components often come apart (often due to foot traffic), leading to water waste and water not going to where it is intended. In this condition, the advantages of a drip system can quickly be lost.
 - For most applications, ½-inch dripline is a lower maintenance, more resilient option.
- Multiple-outlet manifolds are available and should be used with caution as they use ¼-inch tubing and fittings.
 - If multiple outlet manifolds are used, they should be protected by installation in a emitter box.

Figure 5-20: Left to right (1) Rain Bird 1.0 GPH emitter, (2) Toro flag emitters, (3) Rain Bird 6-Outlet Manifold, (4) Hunter IH Riser (images courtesy of Rain Bird Corporation, The Toro Company, and Hunter Industries Inc)



5.8 **Low-volume bubblers** (Figure 5-21) apply water to a small radius around the emission device and have a flow rate many times higher than point-source drip emitters, typically 0.25 to 2.0 GPM (15 to 120 GPH). Application of water can be in an umbrella pattern or fixed streams, and is sometimes adjustable.

- Low-volume bubblers are suitable for applying water to larger shrubs and trees in tree wells.
- They can be a more robust choice in a commercial landscape application and to reduce long term maintenance.
- Bubblers can be used in conjunction with other devices to deliver water directly to the plant root zone in close proximity to the bubbler (Figure 5-21 image 2).

Figure 5-21: Left to right images courtesy of (1) and (2) Hunter Industries Inc, (3) Rain Bird Corporation, and (4) The Toro Company



5.9 **Micro-spray** (Figure 5-22) emitters apply water in a fine spray with a typical flow rate of 0 to 30 GPH. The radius of throw is larger than for bubblers.

- Dripline or point-source drip should be used in place of micro-spray whenever possible due to the potential for overspray and evaporation from micro-spray.
- If overhead spray is appropriate, use a high-efficiency rotating sprinkler system. It is more robust and less prone to clogging and breaking.
- Micro-spray is suitable for starting seeds and establishing vegetable starts.

Figure 5-22: Left to right images courtesy of (1) Hunter Industries Inc, (2) The Toro Company, and (3) Rain Bird Corporation



5.10 **Soaker hose** and **laser tubing** are alternative application devices. Soaker hose is porous tubing that emits water along its entire length. Laser tubing is tubing that simply has small holes drilled into it using a laser. These products are not recommended for efficient irrigation as they do not have a reliable or known flow rate, are prone to clogging, and are not pressure compensating so the amount of water applied will not be uniform along the length of the line.

5.11 Water efficiency features that are available on many emission devices.

- **Matched precipitation rate** (MPR) emission devices serve to improve the uniformity of coverage of an irrigation zone.
 - Modern fixed and rotating spray sprinklers have matched precipitation rates. Use caution with older sprinklers that may not have matched precipitation rates (Figure 5-23).
 - Nozzles on rotors need to be changed when the arc is changed in order to achieve a matched precipitation rate. For example, a half-circle head should have a nozzle with half of the flow of that in the full-circle head. Certain manufacturers produce matched precipitation rate nozzles for single-stream rotors.
 - Do not mix emission devices from different manufacturers, as they will likely have different precipitation rates that will result in poor uniformity of coverage.
- A **check valve** is a valve that closes to prevent the backward flow of water. Emission devices that include a check valve contain the water in the lateral lines when the zone has completed its watering cycle. By preventing water left in the lateral lines from leaking out, check valves can save significant amounts of water.
 - Check valves are particularly effective for irrigation systems that are on a slope (**low head drainage**), and when irrigation is performed using multiple cycles (**cycle and soak**).
 - Preventing low head drainage has the additional benefits of preventing property damage (often damage to asphalt due to water pooling on it) as well as preventing slip and fall hazards from water draining onto sidewalks and other walking services.
- **Pressure regulation** within spray bodies compensates for high or fluctuating water pressure that can result in misting or poor performance.
- **Pressure compensating emitters** are designed to deliver an even flow of water even with changes in pressure across the line. Pressure compensating emitters are particularly useful where there are significant elevation changes in the landscape, or where there are long runs of irrigation lines such that the pressure loss due to friction would be significant.

Figure 5-23: Old Champion sprinkler



5.12 Irrigation practices and emission devices to avoid include installing and operating:

- Emission devices and components where the operating pressure is above or below the manufacturers specifications.
- Emission devices that do not have MPR on a single irrigation valve.
- Emission devices with mixed application rates on a single irrigation valve, e.g. drip line and microspray, or fixed spray sprinklers with rotating sprinklers.
- Emission devices with an unknown or uneven application rate such as soaker hose and laser tubing.
- Emission devices with an application rate that exceeds the infiltration rate of the soil, e.g. fixed spray on clay soils can only be operated with short run times to prevent runoff.
- Overhead spray that is blocked by plant material.
- Emission devices and components that are likely to become damaged, e.g. ¼ inch spaghetti tube and multiple-outlet manifolds for point-source drip.
- Drip emitters positioned at the base of the plant stem or trunk.

6 IRRIGATION SYSTEMS REVIEW QUESTIONS

- 6.1 What are the two types of water pressure?
- 6.2 What happens to water pressure as water travels through the irrigation system?
- 6.3 True or false: For a given flow rate, the smaller the pipe diameter the greater the friction loss.
- 6.4 What is the change in pressure for a 1-foot increase in elevation?
- 6.5 What device protects the potable water supply from contamination?
- 6.6 True or false: Reduced pressure models are the most reliable backflow prevention device.
- 6.7 What is the term for a grouping of irrigation valves?
- 6.8 True or false: Drip irrigation valves should have pressure regulation and filter components installed to operate properly.
- 6.9 How much higher must an anti-siphon valve be installed, relative to the highest emission device on the zone, in order to operate properly?
- 6.10 What is purple PVC pipe used for?
- 6.11 True or false: Fixed spray sprinklers have a higher precipitation rate than rotors.
- 6.12 True or false: Rotating sprinklers offer more uniform coverage than fixed spray sprinklers.
- 6.13 True or false: Drip irrigation can achieve a higher uniformity of coverage than overhead irrigation.
- 6.14 Why is it important not to mix drip emitters and bubblers on the same valve?

Section 6:
**IRRIGATION
MAINTENANCE &
TROUBLESHOOTING**

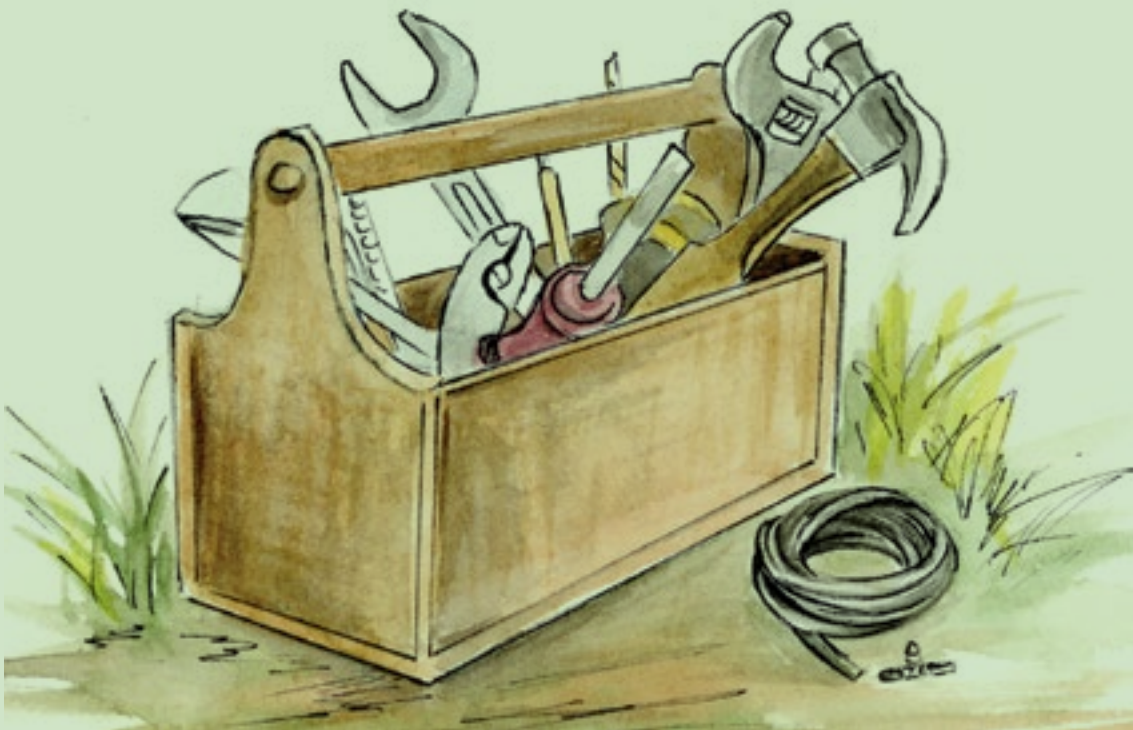



IRRIGATION MAINTENANCE & TROUBLESHOOTING

Learning Objectives

1. Understand the reasons for performing irrigation systems maintenance
2. Understand how to perform a preseason irrigation system inspection and maintenance checkup
3. Understand how to perform an end of season irrigation system shut down
4. Learn how an irrigation valve works
5. Learn how to identify and troubleshoot irrigation valve and controller problems

1 SEASONAL IRRIGATION SYSTEMS MAINTENANCE

- 1.1 Regular maintenance is essential to the proper operation of an efficient irrigation system over time. Performing maintenance at regular intervals can prevent water waste, extend the useful life of the irrigation system, save plants, and save money.
- 1.2 If a landscape site has a [maintenance contract](#), it should include terms to cover the cost of routine irrigation system checks and repairs.

2 PRESEASON INSPECTION AND MAINTENANCE CHECKUP

- 2.1 Irrigation controller check-up (Figure 6-1).
 - Check the date and time on the controller and reset if necessary.
 - Adjust the irrigation controller for a spring schedule.
 - Further information is provided in Sections 8 and 9.
 - Replace the back-up battery if necessary.
 - It is recommended to change the battery at least every other year.
 - Activate the valves.

Figure 6-1: Various examples of controllers on location



- 2.2 Flush the irrigation system to remove dirt and debris that might have built up.
 - Flush filter(s) on drip irrigation zones.
 - Remove the end cap, bubbler, or sprinkler head that is farthest away from valve.
 - Turn on the valve for 30 seconds or until the water runs clear.
 - Turn off the valve and replace end cap or sprinkler head.
 - Clean individual sprinkler screens.
- 2.3 Irrigation system check-up.
 - Activate the valves.
 - [Look](#), [listen](#), and [feel](#). Walk the irrigated area and:
 - Check and adjust water pressure.
 - Clear clogged nozzles.
 - Adjust arcs of variable arc nozzles and rotors to prevent overspray.

- Adjust the radius of throw of overhead spray if out of adjustment. If alignment keeps going out when valve is turned on, replace the entire spray head.
 - Realign tilted, sunken, or raised sprinkler heads.
 - Inspect the area around pop-up spray heads when running for leaks that indicate worn wiper seals or loose caps.
 - Where possible, remove plant material that is blocking spray heads, or move spray heads to keep spray off of tree trunks.
 - Clean drip filters to ensure proper function.
 - Listen to zones with drip irrigation for sounds that might indicate missing emitters or fittings, and punctured or leaking lines.
 - Inspect drip emitters and fittings for cracks and other damage.
 - Replace missing drip emitters and fittings.
 - Repair severed driplines.
- Flag all troubled areas and write the issue on the flag.
 - Fix all flagged areas using the same fixtures and components.
 - When making repairs use the identical hardware to ensure that the application rate remains as specified. Do not use incorrect hardware just because it is on hand.
 - Repeat with all hydrozones.

Figure 6-2: Left to right (1) (2) tilted sprinkler heads, (3) missing drip emitter, (4) severed drip line



3 END OF SEASON IRRIGATION SYSTEM SHUT DOWN

3.1 In many areas, irrigation is not required during the winter months. Preparing the irrigation system for the winter months will protect system components and extend their useful life.

- Clean filters to leave the system clean over the winter.
- Turn off the water to the irrigation system at the main valve.
- Open each of the valves to release pressure in the pipes. Close valves once pressure has been released.
- Set the Irrigation controller to the "rain", "suspend", or "off" setting.
- Drain water out of irrigation components that might freeze.
- Install a freeze blanket on backflow device.
- Additional steps may be needed in areas prone to freezing, e.g. blow out lines with compressed air.

4 VALVE ANATOMY AND OPERATION

- 4.1 An irrigation valve (Figure 6-3) allows water to pass through to the landscape when the diaphragm moves up, and stops water from passing through when the diaphragm moves down.
- 4.2 The valve is opened when one of the two ports is opened, allowing water in the upper chamber to leave the valve. This results in higher pressure below the diaphragm, which pushes the diaphragm up to open the valve.
 - The **solenoid port** is opened when provided with an electrical impulse from the controller that activates a magnet and causes a small metal plunger to move upward. It is typically possible to turn the valve on manually by turning the solenoid about ¼ turn counter clockwise.
 - The **flush valve** or **manual bleed port** is opened by turning the knob to manually bleed water from the upper chamber. Water will spray out of the top of the valve. Use caution not to completely remove the flush valve.
- 4.3 The **flow control** regulates the amount of water that passes through the valve; it should not be used to turn the valve on or off.

Figure 6-3: Valve cutaway (image courtesy of Rain Bird Corporation)

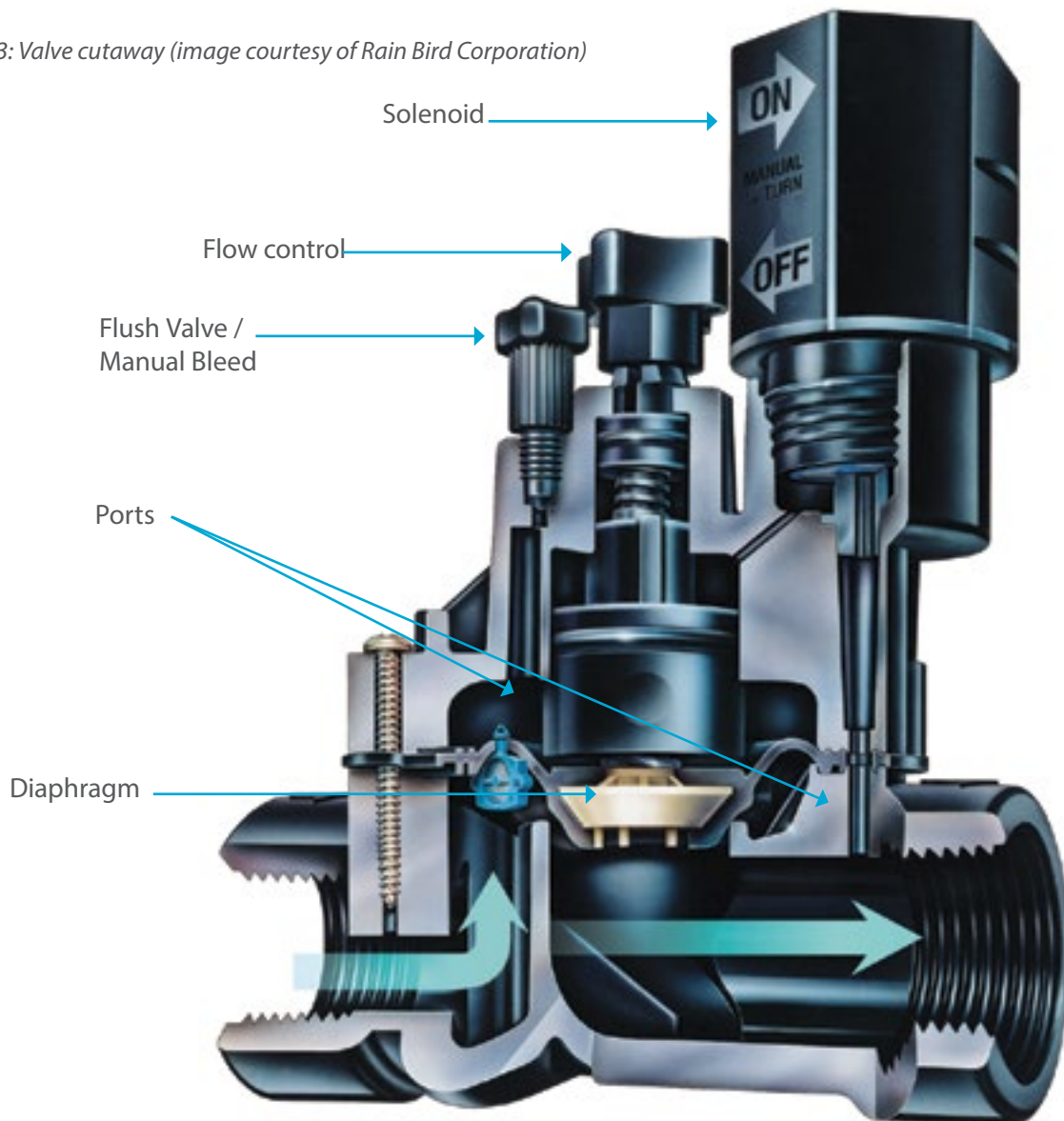

5 VALVE, CONTROLLER, AND FIELD WIRE TROUBLESHOOTING

5.1 There are three possibilities for valve malfunction. Use a consistent and logical process of elimination to find the issue. Start either at the controller and work towards the valve, or at the valve and work towards the controller.

- **Hydraulic:** impaired water flow.
- **Mechanical:** something physically stopping the valve from operating.
- **Electrical:** an issue with the valve solenoid, the field wiring, or the irrigation controller.

5.2 Steps for troubleshooting:

- Check that the **water** is on at the point of connection (POC).
- Check the **controller**.
 - Check that there is **power** to the controller.
 - Check the controller **program**.
 - Check fuses and sensors.
 - Verify power using a volt/ohm meter.
 - Check the station output terminals.
 - Look for critters in the controller panel that could be interrupting the electrical signal.
- Check the **valve**.
 - Open the valve manually by turning the **solenoid**. If the valve opens, the issue is electrical.
 - Open the valve using the **flush valve/manual bleed**. If the valve does not open, the issue is hydraulic or mechanical.
- If the problem is electrical:
 - Check field wire connections at controller terminals and at the valve.
 - Look for broken or cut wires.

5.3 Valve won't open.

Table 6-1: Troubleshooting guide for a valve that won't open

Cause	Solution
Valve tuning (flow control)	Tune the valve using the flow control. If the flow control is too tight, the diaphragm cannot rise to allow the valve to open.
Bad solenoid	Functional solenoids click when activated. Use volt/ohm meter to determine if there is a continuity issue. Replace solenoid if not functioning.
Valve mechanism clogged or damaged	Flush debris from valve using flush port. If unsuccessful, valve requires disassembly to clean ports and diaphragm. Replace diaphragm if necessary.
Poor wire connection	Reconnect and seal connection with water proof connectors.
Controller problem	Use volt/ohm meter to determine if the controller is sending a 24V signal. Issue could be fuse, transformer, or controller.
No power to valve	Use volt/ohm meter to determine if there is a continuity issue. Repair or replace wiring.

5.4 Valve won't close.

- Symptoms of a valve that doesn't properly close include sprinklers / emitters running when the system is off, and water flowing from the lowest head (weeping valve).

Table 6-2: Troubleshooting guide for a valve that won't close

Cause	Solution
Controller problem	Check controller and adjust start times in all programs as needed. Try turning the controller off, and turning off the power to the controller.
Valve manually opened	Check that the flush valve is properly closed and that the solenoid is tight to enable pressure to build on top of the diaphragm.
Valve tuning (flow control)	<ol style="list-style-type: none"> 1. Manually or electrically activate the valve. 2. Fully open the flow control valve (counterclockwise) 3. Slowly close the flow control valve ¼ turn at a time until the spray patterns dip/reduce. 4. Back off ½ turn. 5. Do not use the flow control valve to reduce pressure.
Valve mechanism clogged or damaged	<p>Flush debris from valve using flush port. If unsuccessful, valve requires disassembly to clean ports and diaphragm.</p> <ul style="list-style-type: none"> • Replace diaphragm if necessary. • Check for damaged valve seat. • Check solenoid plunger for deterioration. • Check for cracks in the valve body or bonnet and integrity of seals.

6 IRRIGATION MAINTENANCE & TROUBLESHOOTING

REVIEW QUESTIONS

- 6.1 Why is it important to perform regular maintenance on irrigation systems?
- 6.2 What would you do to prepare an irrigation controller for the irrigation season?
- 6.3 What steps would you take to conduct a check-up on irrigation system at the beginning of the irrigation season?
- 6.4 What steps would you take to prepare an irrigation system to be shut down at the end of the irrigation season?
- 6.5 Describe the function of an irrigation valve.
- 6.6 Describe how an irrigation valve is opened by the irrigation controller.
- 6.7 Describe two methods of manually operating an irrigation valve.
- 6.8 What are the three possibilities for valve malfunction?

Section 7:
**IRRIGATION SYSTEM
AUDITING**

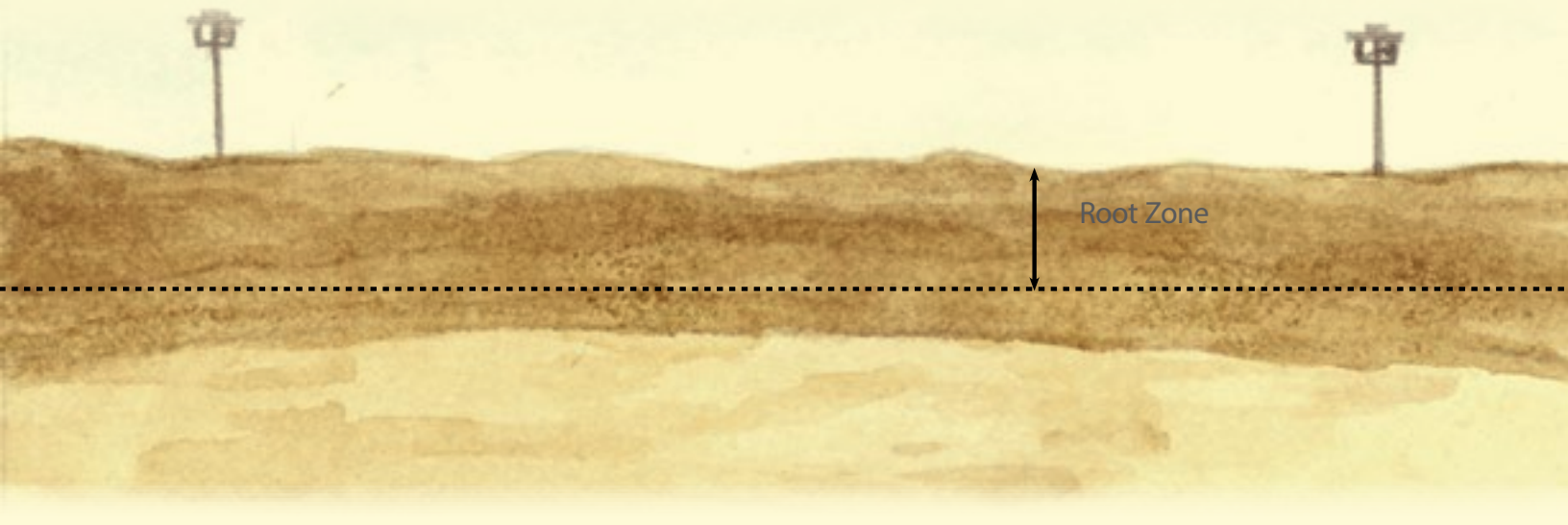



IRRIGATION SYSTEM AUDITING

Learning Objectives

1. Understand the reasons for conducting an irrigation system audit
2. Have a basic understanding of the terms ‘distribution uniformity’ and ‘irrigation efficiency’
3. Have a basic understanding of the terms ‘precipitation rate’ and ‘matched precipitation rate’
4. Know how to determine the precipitation rate
5. Understand the tools required to conduct an irrigation system audit
6. Understand how to conduct an irrigation system audit site evaluation
7. Understand how to conduct an irrigation system audit tune-up
8. Understand how to conduct an irrigation system audit test for overhead spray
9. Understand how to conduct an irrigation system audit test for drip irrigation

1 PURPOSE OF IRRIGATION SYSTEM AUDITING

- 1.1 The purpose of an irrigation system audit is to **assess how effective an irrigation system** is at applying water to a specific hydrozone.
- 1.2 The results of the irrigation audit can be used to **develop an irrigation schedule** for the hydrozone tested. An accurate irrigation schedule helps to ensure that water is used as efficiently as possible within the limits of the irrigation system.
- 1.3 Observations made during the audit can be used to **suggest system improvements**. Optimizing irrigation system performance helps to improve the efficiency with which irrigation water is applied.

2 DISTRIBUTION UNIFORMITY & IRRIGATION EFFICIENCY

- 2.1 **Distribution uniformity (DU)** is a measurement of how evenly water is applied to a hydrozone. **Irrigation efficiency (IE)** is the ratio of the volume of water that is beneficially used by the plants in a hydrozone to the volume of irrigation water applied.
 - DU is a value between zero and 1.0, where 1.0 represents perfect uniformity. DU can be expressed as a decimal or a percentage.
 - IE is usually expressed as a percentage, where 100% is perfect efficiency.
- 2.2 A high DU is desirable because it allows the entire root zone to be irrigated sufficiently and evenly. It also helps to ensure adequate plant health. If DU is low, it is necessary to overwater in order to compensate for the uneven application of water.
 - Figure 7-1 shows a sports field with poor DU.
 - Figures 7-2 and 7-3 illustrate a cross section of a hydrozone with poor DU. The dashed line represents the bottom of the root zone. Irrigation water that moves beyond the root zone is lost to deep percolation. Figure 7-2 illustrates the overwatering necessary to properly irrigate the entire area, whereas figure 7-3 illustrates insufficient watering of certain areas if water waste is to be avoided.
- 2.3 Irrigation efficiency (IE) differs from DU because it also takes into account factors that are not captured by DU, such as overspray, runoff, and run time of the irrigation system.
 - An irrigation system with significant overspray might have a high DU but will have low IE.
 - An irrigation system with a high DU, but with an application rate significantly higher than the infiltration rate of the soil, will have a low IE.

Figure 7-1: Irrigation circles on a sports field, a common indicator of poor DU

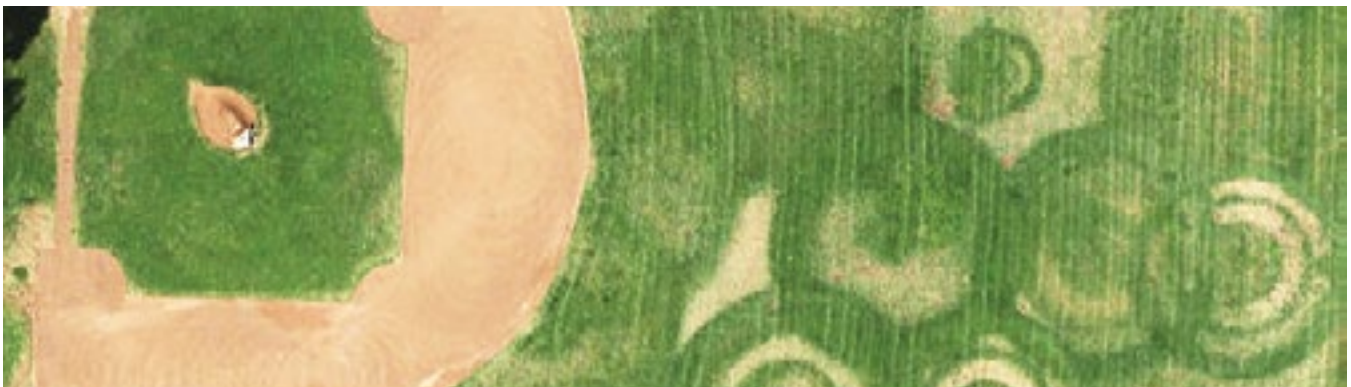

Figure 7-2: Excessive watering with poor DU

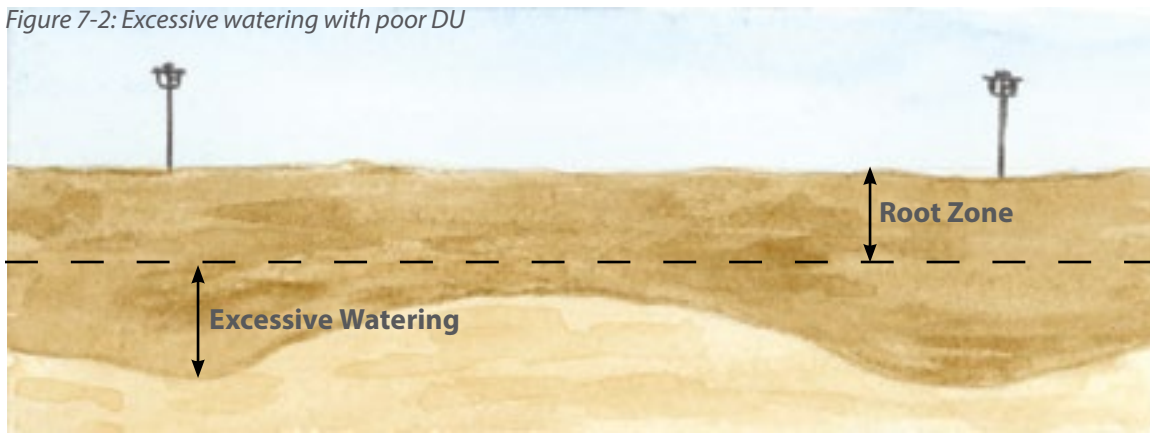

Figure 7-3: Insufficient watering with poor DU

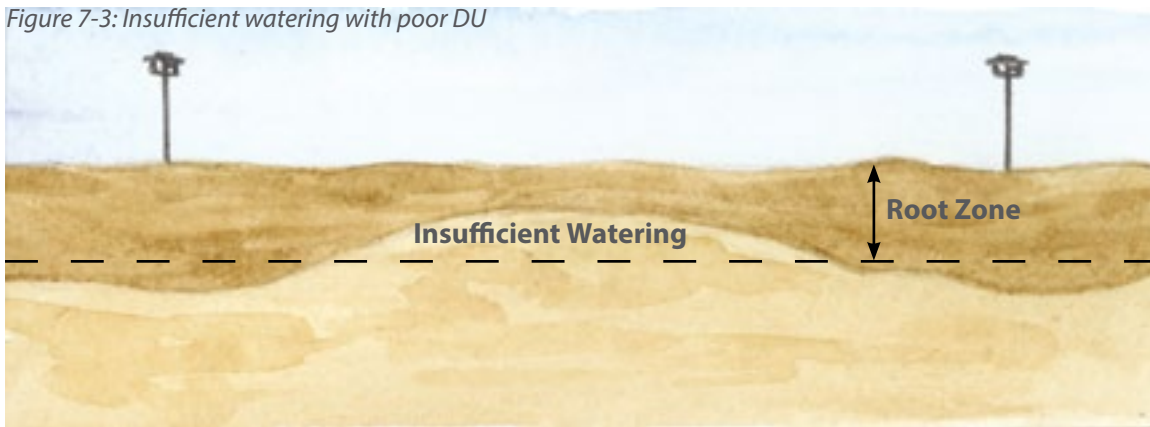
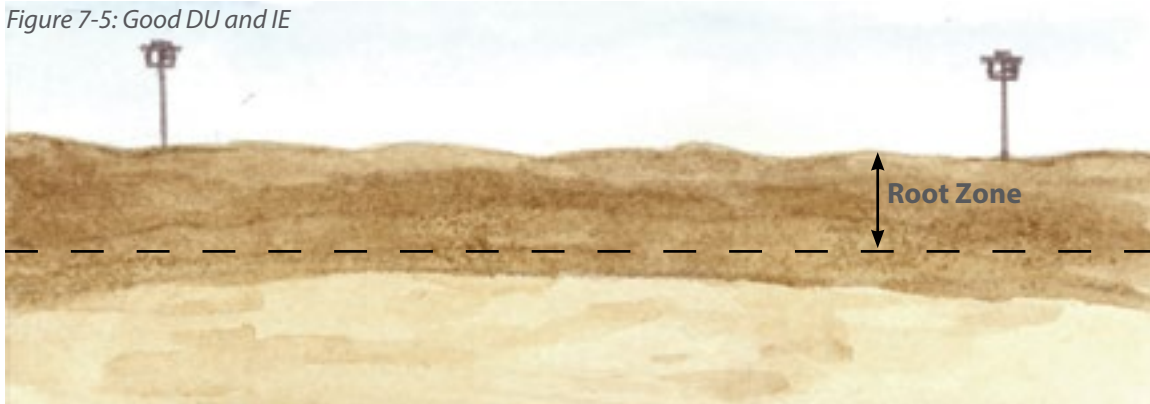

Figure 7-4: Good DU with poor IE



Figure 7-5: Good DU and IE



- Note that a high IE does not always translate to a healthy landscape, e.g. high IE can be achieved by under watering because more of the water applied will be beneficial.
- Figures 7-4 and 7-5 illustrate a cross section of a hydrozone with good DU. Figure 7-4 has poor IE due to overwatering, whereas figure 7-5 has good IE, as the water manager is irrigating to the proper depth.

2.4 Certain irrigation emission devices inherently apply water more evenly than others. Drip irrigation will typically have a higher DU than spray sprinklers. Table 7-1 shows typical DU values for different emission devices.

Table 7-1: Typical DU values for different types of irrigation system

Irrigation System	Distribution Uniformity
Drip irrigation	0.80 – 0.95
Rotating sprinkler	0.55 – 0.85
Rotors	0.55 – 0.85
Spray sprinklers	0.45 – 0.75

2.5 Overhead irrigation devices, such as sprinklers, are designed to have overlapping coverage as the spray pattern of individual sprinklers are typically not uniform for their entire diameter of throw.

- **Head-to-head coverage** of sprinkler spray patterns is typically used to ensure optimal DU. By ensuring that the spray of one sprinkler goes all the way to the next, coverage between the two is uniform. Figure 7-6 illustrates the spray pattern for two sprinklers with head-to-head coverage.
- When **wind** is considered an issue, sprinklers should be placed even closer, perhaps as much as 45% of the diameter of throw.
 - Whenever possible, use drip irrigation in high wind areas.

Figure 7-6: Head-to-head coverage

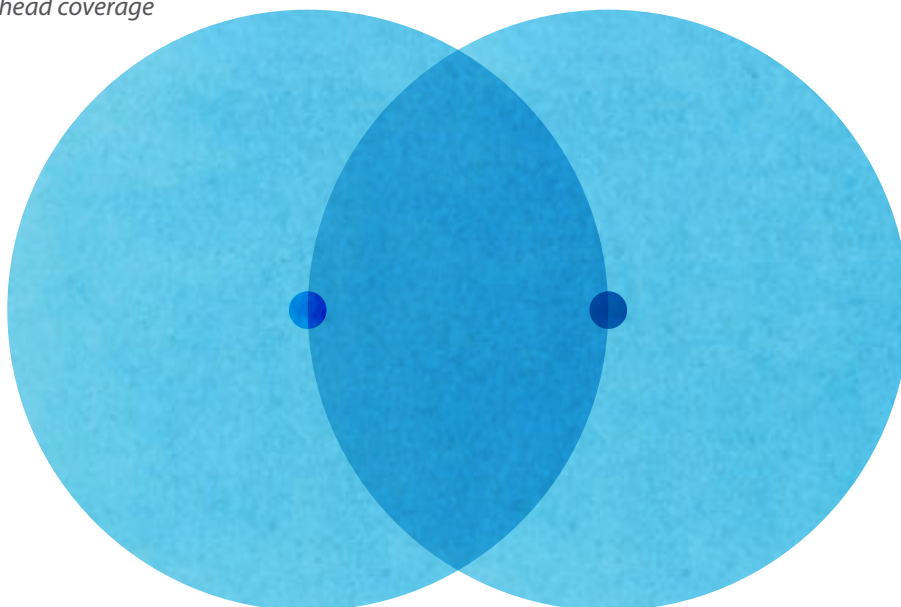

2.6 Leading causes of poor DU and IE include:

- Improper head spacing (less than head-to-head spacing).
- Use of different head types in the same zone, e.g. rotors with spray sprinklers.
- Mismatched nozzles resulting in uneven application.
- Water pressure that is too high, causing misting, or too low, reducing the radius of throw.
- Overspray.
- Wear and tear of irrigation equipment over time without proper maintenance.
- Clogged heads or nozzles.
- Broken or missing heads.
- Tilted heads or heads below grade.
- Spray pattern blocked by hardscape features or plant material.
- Leaking seals.
- Missing emitters.
- Severed drip lines.

Figure 7-7: Clockwise (1) overspray, (2) tilted head, (3) head below grade, (4) severed drip line, (5) missing emitter, (6) leaking seals



3 PRECIPITATION RATE & MATCHED PRECIPITATION RATES

- 3.1 The **precipitation rate** (PR) is the rate at which water is applied measured in inches per hour. The **gross precipitation rate** measures the total flow of the hydrozone, whereas the **net precipitation rate** applied measures only the water that is effectively applied to the hydrozone landscape area. The difference between the gross PR and the net PR are water losses due to factors such as leaks, overspray, run-off, and wind drift.
- 3.2 Different irrigation application devices have different PRs. The PR will also vary depending on how the application device is laid out. Table 7-2 shows typical PRs for different application devices.

Table 7-2: Typical precipitation rates of irrigation devices

Application device	Precipitation Rate (in/hr)
Fixed spray sprinklers	1.5 – 2.0
Rotating sprinklers	0.4 – 0.8
Rotors	0.25 – 1.50
Inline drip	0.1 – 2.0 (grid)
Point-source drip	Depends on emitter placement
Low-volume bubblers	Depends on flow rate and wetted area

- 3.3 It is important to know the PR in each hydrozone in order to properly determine the appropriate irrigation run time.
- Irrigation run time is covered in Section 8 Irrigation Scheduling
- 3.4 Within a hydrozone, make sure that the PR of individual emission devices is matched to ensure an even rate of water application.
- Table 7-3 provides an example of matched precipitation rate (MPR) rotating sprinklers.
 - When the PR is matched, the flow rate of the emission device increases as the arc increases. The flow rate of a 180-degree head is double that of a 90-degree head.

Table 7-3: Matched precipitation rate example: Hunter Industries MP Rotator MP1000 (8-15-feet) at 40 PSI using a square head layout

Arc	Flow (GPM)	Precipitation Rate (inches / hour)
90-degree	0.21	0.41
180-degree	0.42	0.41
270-degree	0.63	0.41
360-degree	0.84	0.41

- Table 7-4 provides an example of unmatched PR rotors.
 - When the PR is unmatched, the flow rate of the emission device remains constant as the arc increases. The precipitation rate of a 180-degree head is half that of a 90-degree head.
 - The PR of rotors can be matched using different nozzles depending on the arc of the rotor.
 - Alternatively, rotors with different arcs can be grouped together on separate irrigation valves with different run times, e.g. only 90-degree rotors on one valve or valves, and only 360-degree rotors on a separate valve or valves.
 - If older sprinklers are encountered that do not have a matched PR, they should be retrofitted with new matched PR sprinklers (preferably high-efficiency rotating sprinklers).

Table 7-4: Unmatched precipitation rate example: Hunter Industries I-40 Rotor with gray nozzle at 60 PSI using a square head layout

Arc	Flow (GPM)	Precipitation Rate (inches / hour)
90-degree	15.7	2.00
180-degree	15.7	1.00
270-degree	15.7	0.67
360-degree	15.7	0.50

4 PRECIPITATION RATE CALCULATION

4.1 **Manufacturers specifications** can be used to look up the **gross PR** of a hydrozone.

- It is necessary to know some specifics about the emission device in order to look up the precipitation rate.
 - Brand, model, nozzle, static water pressure, spacing pattern, and spacing dimensions.
- Figure 7-8 shows an example of performance specifications for **overhead emission devices**.
 - Flow and PR vary by radius of throw and static water pressure.
 - Manufacturers typically publish the PR for sprinklers laid out in a **square** pattern and a **triangular** pattern.
 - The actual PR will vary due to factors such as differences in system layout, changes in system pressure, overspray, and wind drift.
- Figure 7-9 shows an example of performance specifications for **dripline**.
 - Manufacturers typically publish PRs for dripline laid out in a grid.
 - PR varies by emitter flow rate, **emitter spacing** on the dripline, and **lateral spacing** of dripline.
 - The flow rate and PR of most dripline should be constant at different pressures within the range published by the manufacturer.
 - Actual PR will vary due to differences in line spacing in the field.

Figure 7-8: Hunter Industries MP Rotator performance data (image courtesy of Hunter Industries Inc)

MP ROTATOR PERFORMANCE DATA																		
	MP1000 Radius: 8' to 15' Adjustable Arc and Full-Circle ● Maroon: 90° to 210° ● Lt. Blue: 210° to 270° ● Olive: 360°						MP2000 Radius: 13' to 21' Adjustable Arc and Full-Circle ● Black: 90° to 210° ● Green: 210° to 270° ● Red: 360°						MP3000 Radius: 22' to 30' Adjustable Arc and Full-Circle ● Blue: 90° to 210° ● Yellow: 210° to 270° ● Gray: 360°					
Arc	Pressure PSI	Radius ft.	Flow GPM	Flow GPH	Precip in/hr	Precip in/hr	Radius ft.	Flow GPM	Flow GPH	Precip in/hr	Precip in/hr	Radius ft.	Flow GPM	Flow GPH	Precip in/hr	Precip in/hr		
90°	25	--	--	--	--	--	17	0.34	20.4	0.45	0.52	25	0.71	42.6	0.44	0.51		
	30	12	0.17	10.2	0.45	0.52	18	0.38	22.8	0.45	0.52	27	0.76	45.6	0.40	0.46		
	35	13	0.19	11.4	0.43	0.50	19	0.40	24.0	0.43	0.49	28	0.82	49.2	0.40	0.46		
	40	14	0.21	12.6	0.41	0.48	20	0.43	25.8	0.41	0.48	30	0.86	51.6	0.37	0.42		
	45	14	0.23	13.8	0.45	0.52	21	0.46	27.6	0.40	0.46	30	0.90	54.0	0.39	0.44		
	50	15	0.25	15.0	0.43	0.49	21	0.47	28.2	0.41	0.47	30	0.95	57.0	0.41	0.47		
180°	25	--	--	--	--	--	16	0.6	36.0	0.45	0.52	25	1.44	86.4	0.44	0.51		
	30	12	0.34	20.4	0.45	0.52	17	0.64	38.4	0.43	0.49	27	1.58	94.8	0.42	0.48		
	35	13	0.38	22.8	0.43	0.50	18	0.71	42.6	0.42	0.49	28	1.70	102.0	0.42	0.48		
	40	14	0.42	25.2	0.41	0.48	19	0.77	46.2	0.41	0.47	30	1.82	109.2	0.39	0.45		
	45	14	0.44	26.4	0.43	0.50	20	0.85	51.0	0.41	0.47	30	1.93	115.8	0.41	0.48		
	50	15	0.50	30.0	0.43	0.49	21	0.91	54.6	0.40	0.46	30	2.04	122.4	0.44	0.50		
55	15	0.51	30.6	0.44	0.50	21	0.95	57.0	0.41	0.48	30	2.13	127.8	0.46	0.53			

Figure 7-9: Netafim Techline CV precipitation rate chart (image courtesy of Netafim USA)

GENERAL GUIDELINES	TURF								SHRUB & GROUNDCOVER															
	CLAY SOIL		LOAM SOIL		SANDY SOIL		COARSE SOIL		CLAY SOIL		LOAM SOIL		SANDY SOIL		COARSE SOIL									
EMITTER FLOW	0.26 GPH		0.4 GPH		0.6 GPH		0.9 GPH		0.26 GPH		0.4 GPH		0.6 GPH		0.9 GPH									
EMITTER SPACING	18"		12"		12"		12"		18"		18"		12"		12"									
LATERAL (ROW) SPACING	18"	20"	22"	18"	20"	22"	12"	14"	16"	12"	14"	16"	18"	21"	24"	18"	21"	24"	16"	18"	20"	16"	18"	20"
BURIAL DEPTH	Bury evenly throughout the zone from 4" to 6"								On-surface or bury evenly throughout the zone to a maximum of 6"															
APPLICATION RATE (INCHES/HOUR)	0.19	0.17	0.15	0.30	0.27	0.25	0.98	0.84	0.73	1.48	1.27	1.11	0.19	0.16	0.14	0.30	0.26	0.23	0.73	0.65	0.59	1.11	0.99	0.89
TIME TO APPLY ¼" OF WATER (MINUTES)	80	89	97	50	55	61	15	18	20	10	12	13	80	93	106	50	58	66	20	23	26	13	15	17

Following these maximum spacing guidelines, emitter flow selection can be increased if desired by the designer.
0.9 GPH flow rate available for areas requiring higher infiltration rates, such as coarse sandy soils.

4.2 Flow rate formulas can be used to determine the gross PR of a hydrozone.

- In order to use these formulas, it is necessary to know the total flow of the hydrozone.
- The most accurate method of determining the flow of the hydrozone is to measure it using a water meter.
 - Activate the system to remove any air from the lines.
 - Take a meter reading and then allow the hydrozone to run for a certain amount of time (e.g. 5 mins for spray, 10 mins for drip).
 - Take a second meter reading at the end of the time.
 - If the meter reading is in CCF first convert to gallons by multiplying by 7.48.
 - The flow rate is the number of gallons delivered divided by the run time in minutes.
- An alternative method is to look up the flow rate of the emission devices installed using manufacturers specifications.
 - Sum the flow rates of the individual emission devices to obtain the flow rate for the hydrozone.
 - Convert drip emitter flow rates from GPH to GPM by dividing the flow in GPH by 60.

- General PR formula used for spray irrigation and drip irrigation

$$PR = \frac{96.3 \times GPM}{HA} \quad \text{where}$$

- PR = precipitation rate (inches/hour)
- GPM = total flow rate of the hydrozone (gallons per minute)
- HA = hydrozone area (square feet)
- 96.3 = constant to convert gallons per minute to inches per hour (60 min per hour divided by 7.48 gallons per cubic foot multiplied by 12 inches per foot)

- PR formula for dripline laid out in a grid

$$PR = \frac{231.1 \times GPH}{\text{Emitter spacing} \times \text{Row spacing}} \quad \text{where}$$

- PR = precipitation rate (inches/hour)
- GPH = individual emitter flow rate (gallons per hour)
- Emitter spacing = distance between emitters on the dripline (inches)
- Row spacing = distance between rows of dripline (inches)
- 231.1 = constant to convert units

4.3 PR calculation examples.

- Square hydrozone measuring 28 feet by 28 feet irrigated with Hunter MP1000 rotating sprinklers in a square pattern and an operating pressure of 40 PSI.
 - 4 90-degree heads with a flow of 0.21 GPM each (4 x 0.21 = 0.84 GPM)
 - 4 180-degree heads with a flow of 0.42 GPM each (4 x 0.42 = 1.68 GPM)
 - 1 360-degree head with a flow of 0.84 GPM
 - GPM = 0.84 + 1.68 + 0.84 = 3.36 GPM
 - HA = 28 x 28 = 784 square feet
 - PR = (96.3 x 3.36) / 784 = 323.57 / 784 = 0.41 in/hr
- Rectangular hydrozone measuring 30 feet by 60 feet irrigated with Netafim Techline CV laid out in a grid with 0.4 GPH emitters, 18 inch emitter spacing, and 18 inch row spacing.
 - 0.4 GPH is the nominal flow, the actual flow rate is 0.42 GPH
 - PR = (231.1 x 0.42) / (18 x 18) = 97.06 / 324 = 0.30 in/hr

4.4 Perform a [catch-can test](#) to determine the [net PR](#) of a hydrozone.

- This is the preferred method of calculating the PR for [overhead irrigation](#) since it measures only the water effectively applied to the landscape hydrozone area and does not take account of any water lost due to factors such as leaks and overspray.
- Learning Objective 8, Irrigation System Audit - Irrigation System Testing - Overhead Spray below details how to perform a catch-can test.

5 IRRIGATION SYSTEM AUDIT TOOLS

5.1 Catch cans are containers that are laid out in the hydrozone to catch water from overhead spray application devices in order to **measure the DU** and **PR**. All catch cans used for a test should be of uniform shape and size. While any container can be used as a catch can, there are several specialized containers available that allow faster measurement (Table 7-5 and Figure 7-10). Specialized cans either have integrated stands or require separate metal stands.

Table 7-5: Common catch can types

Can Type	Measurement Scale	Catchment Area (square inches)	Source
Cal Poly / ITRC / DWR	ml	16.25	http://www.itrc.org
Texas A&M System	ml / inches	16.61	http://irrigation.tamu.edu
Utah State University	ml / inches / cm	12.94	http://cwel.usu.edu

Figure 7-10: Netafim Techline CV precipitation rate chart (image courtesy of Netafim USA)

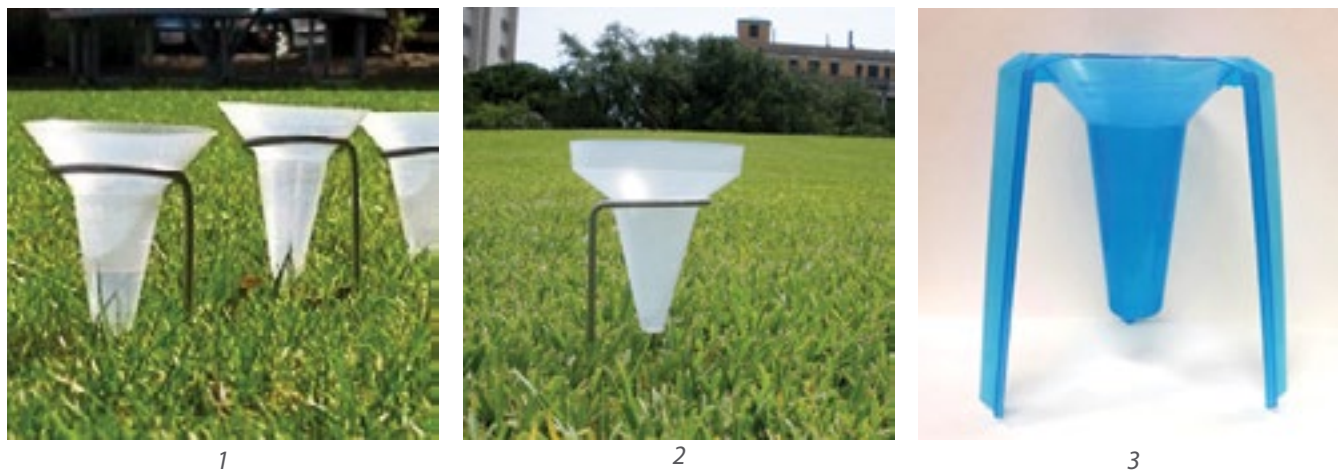

5.2 **Flags** are used to mark the location of irrigation emission devices.

5.3 **Pressure gauges** are used to measure the dynamic pressure of the irrigation system.

- A pitot tube attached to a pressure gauge is used to measure the pressure of rotors as well as drip tubing.
- The pressure of other spray devices is measured using a gauge mounted to a tee and inserted into the stem of the sprinkler (Figure 7-11).

5.4 A **soil probe** is used to determine root depth and assess soil texture.

5.5 A **measuring wheel** or **tape** is used to measure head spacing.

5.6 An **anemometer** is used to measure wind speed.

5.7 A **screwdriver** and device specific tools are used to adjust application devices.

5.8 A **clipboard**, **calculator**, and **stopwatch**.

5.9 A camera to document system issues.

5.10 Rags to clean-up equipment following the audit.

Figure 7-11: Left to right (1) pitot tube, (2) measuring pressure with a pitot tube, (3) gauge mounted to a tee



6 IRRIGATION SYSTEM AUDIT – EVALUATION OF THE SITE AND IRRIGATION SYSTEM

6.1 The first step to an irrigation system audit is to have an understanding of the site and irrigation system being evaluated.

6.2 It is important to understand the goals of the audit that should be established with the client.

6.3 Obtain as much information as possible about the site being audited.

- Landscape design
- As-built irrigation plan
- Aerial images
- Water use records
- Plant material
- Microclimates
- Soil types
- Slopes

6.4 Perform a visual inspection of the irrigation system from the water meter to the emission devices and the controller.

6.5 Activate each irrigation hydrozone and observe issues that might impact system performance.

6.6 Irrigation issues should be noted and either resolved during the system tune-up or noted in the audit report.

6.7 Take photographs of irrigation system components and issues for future reference and for use in the audit report.

- 6.8 Take measurements of the hydrozone(s) to be tested (Figure 7-12)
- 6.9 If there is sufficient information, determine an approximate water budget for the site that can be compared to water use records, and can also be used to calculate the cost savings that might be expected from irrigating more efficiently or performing system upgrades.

Figure 7-12: Landscape measurement example



7 IRRIGATION SYSTEM AUDIT – IRRIGATION SYSTEM TUNE-UP

- 7.1 Depending on the parameters of the audit being conducted, it can be beneficial to [perform a basic system tune-up prior to proceeding with system testing](#).
- 7.2 For new landscapes a system tune-up shouldn't be necessary, but the auditor should look for elements of the system that might be missing and/or not installed properly.
- For example, ensure that drip valves have a filter and pressure regulator installed.
- 7.3 For existing landscapes the auditor should use judgment to make small adjustments. Caution should be used not to damage system components, especially with older systems where components may be corroded and/or brittle. Examples include:
- Check and adjust water pressure
 - Clear clogged nozzles
 - Adjust arcs of variable arc nozzles and rotors to prevent overspray
 - Adjust the radius of throw if it is out of adjustment
 - Rectifying tilted, sunken, or raised sprinkler heads
 - Replacing missing point source emitters
 - Remove plant material that is blocking spray heads, or move spray head
- 7.4 When issues exist that the auditor is not able to rectify, it must be decided whether or not to proceed with system testing.
- If the performance of the system appears reasonable, proceeding with system testing can provide information that might inform upgrades.
 - If the performance of the system is significantly impaired, proceeding with system testing may be an inefficient use of time.

8 IRRIGATION SYSTEM AUDIT – IRRIGATION SYSTEM TESTING – OVERHEAD SPRAY

8.1 Draw a **diagram** of the test area including:

- Overall dimensions
- Head locations
- Head spacing
- Catch can locations

8.2 Measure wind speed using an anemometer. Only conduct an irrigation audit on overhead irrigation systems if the wind speed is **5 mph or less**.

8.3 Run zone to be tested and **mark spray bodies with flags**.

8.4 Place catch cans in zone to be tested.

- Use a **minimum of 24 catch cans** and use a number of cans that can be divided by four.
- Leave a space of about 2 feet between a spray body and a catch can.
- Layout catch cans in a uniform grid.
 - Space cans approximately 5 – 8 feet on center for fixed and rotary spray sprinklers.
 - Space cans approximately 10 – 20 feet on center for rotors.

8.5 Pull flags before running test as they will obstruct the path of the spray.

8.6 Run the irrigation zone for a sufficient amount of time to collect a minimum volume of water of 20 ml for typical manufactured catch cans. Typically 5 – 10 min for spray and 10 mins + for rotors.

- For other can types the volume of water collected will depend upon the size of the can.
- If the test area covers more than one irrigation zone, the run time for each station must be adjusted to achieve a matched precipitation rate across the test area.

8.7 Measure and record the amount of water in each catch can.

- Use scale on catch can if available to measure volume of water in ml or depth of water in inches or centimeters.
- If no scale is available, pour water into a measuring jug or graduated cylinder with an ml scale.
- For catch cans with straight sides and a flat bottom, simply measure the depth of water in inches or centimeters using a ruler.
- Ensure that catch cans are numbered on the diagram so that the location of the measurements is known, as this may help to identify issues with the irrigation system.

Figure 7-13: Example test area diagram

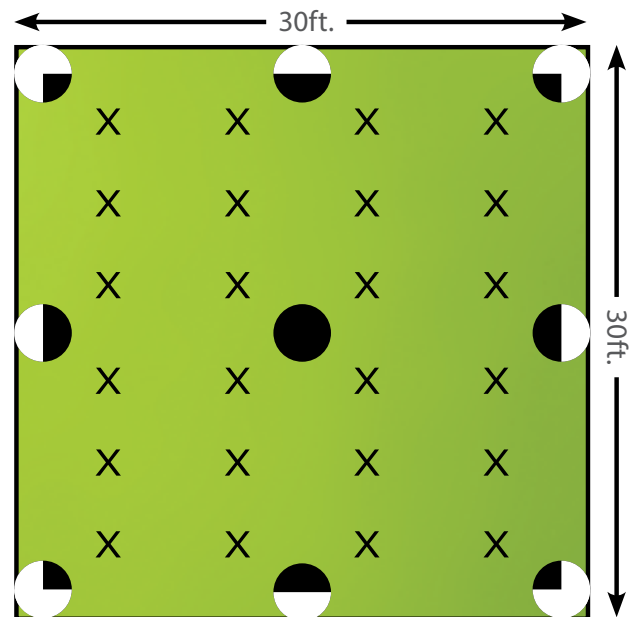

8.8 Calculate the low quarter distribution uniformity:

$$DU_{LQ} = \frac{\text{Average catch volume/depth of low quarter}}{\text{Average catch volume/depth of all cans}} \quad \text{where}$$

- Average catch volume/depth of low quarter is determined by summing the volume of water in ml (or depth of water in inches or centimeters) in the low quarter and dividing by the number of cans in the low quarter.
 - The low quarter is the 25% of catch cans with the lowest volume of water.
- Average catch volume/depth of all cans is determined by summing the volume of water in ml (or depth of water in inches or centimeters) in all cans and dividing by the total number of cans.
 - If using cans with straight sides and a flat bottom but no scale, the depth of water in inches can be measured with a ruler.

8.9 Calculate the net precipitation rate:

- If using volume in ml:

$$PR_{NET} = \frac{\text{Average catch volume of all cans} \times 3.66}{\text{Test run time} \times \text{Catch can throat area}} \quad \text{where}$$

- Average catch volume of all cans is determined by summing the volume of water in ml in all cans and dividing by the total number of cans.
 - Test run time is measured in minutes.
 - Catch can throat area is measured in square inches.
 - 3.66 is a constant to convert ml to cubic inches and minutes to hours (0.061 x 60).
- If using depth in inches or centimeters:

$$PR_{NET} = \frac{\text{Average depth of all cans} \times 60}{\text{Test run time}} \quad \text{where}$$

- Average depth of all cans is measured in inches or centimeters.

8.10 Example calculations:

Catch can data: Test run time 20 mins Catch can throat area 16.25 sq in		
Catch Can Number	Catch Can Volume (ml)	Low Quarter
1	48	
2	40	
3	44	
4	45	
5	35	
6	30	30
7	34	34
8	30	30
9	40	
10	38	
11	34	
12	25	25
13	40	
14	50	
15	75	
16	105	
17	38	
18	56	
19	44	
20	42	
21	27	27
22	50	
23	45	
24	30	30
Sub-total	1,045	176
Average	43.54	29.33

Average catch volume of low quarter

$$= \frac{\text{Sum of catch volume of low quarter}}{\text{Number of cans in low quarter}} = \frac{176}{6} = 29.33$$

Average catch volume of all cans

$$= \frac{\text{Sum of catch volume of all cans}}{\text{Total number of cans}} = \frac{1045}{24} = 43.54$$

$DU_{LQ} = \frac{\text{Average catch volume of low quarter}}{\text{Average catch volume of all cans}} = \frac{29.33}{43.54} = 0.67$

$PR_{NET} = \frac{\text{Average catch volume of all cans} \times 3.66}{\text{Test run time} \times \text{Catch can through area}}$

$$= \frac{43.54 \times 3.66}{20 \times 16.25} = \frac{159.36}{325} = 0.49 \text{ in/hr}$$

9 IRRIGATION SYSTEM AUDIT – IRRIGATION SYSTEM TESTING – DRIP IRRIGATION

- 9.1 It is not common practice to test the uniformity of drip irrigation systems, as it is not practical and is typically very high. Emission uniformity is typically 0.9 for pressure compensating emitters and 0.8 for non pressure compensating emitters.
- 9.2 Drip systems require a thorough evaluation of the site and irrigation system to ensure proper function.
- Measure pressure at a minimum of three locations within the zone. Pressure readings should be taken at the beginning, midpoint and end(s).
 - If the pressure variance is greater than 20%, further investigation is required to find out where the pressure losses are happening and remedy them.
 - Methods for taking pressure readings on drip irrigation:
 - Pressure readings can be taken on drip tubing by inserting a gauge equipped with a pitot tube directly into the tubing. When the zone has completed the irrigation cycle, use a goof plug to plug the hole. Where possible, use three gauges simultaneously to save time and to avoid getting wet.
 - A pressure gauge fitted to ¼-inch tubing can be attached directly to point-source emitters with a barbed fitting, such as flag emitters.
 - A pressure gauge fitted to ¼-inch tubing can be attached to 17 mm dripline using a Netafim emitter micro-tubing adapter (Figure 7-14).
- 9.3 The precipitation rate of a drip irrigation system should be determined using the general PR formula for point-source drip or using the PR formula for dripline laid out in a grid.
- When determining the application rate of a drip zone, the auditor can either perform a flow test using the water meter as described in Section 4.2 above or look up the flow rate of the emission devices installed on the zone.
 - Be careful to only include the area within the hydrozone that will be receiving irrigation in the precipitation rate calculation. Non-wetted areas should be removed from the precipitation rate calculation.
 - Determining the wetted area is relatively simple if the hydrozone is irrigated with a grid of dripline, but more complicated if irrigated with point-source drip.
 - For point-source drip there are several approaches:
 - Estimate the percentage of the hydrozone area that receives irrigation.
 - Estimate the wetted area per emitter and sum them for the hydrozone. Wetted area for each emitter will depend on the flow rate and soil texture.

Figure 7-14: Netafim emitter micro-tubing adapter (image courtesy of Netafim USA)



10 IRRIGATION SYSTEM AUDITING REVIEW QUESTIONS

- 10.1 What is the purpose of an irrigation system audit?
- 10.2 True or false: A high DU is desirable because it allows the entire root zone to be irrigated more evenly.
- 10.3 True or false: DU and IE are the same?
- 10.4 Why is head-to-head coverage of overhead spray desirable?
- 10.5 What are some causes of poor DU and IE?
- 10.6 What is the difference between the gross and net precipitation rate?
- 10.7 True or false: When the PR is matched, the flow rate of the emission device increases as the arc increases?
- 10.8 True or false: When the PR is unmatched, the flow rate of the emission device remains constant as the arc increases?
- 10.9 True or false: Manufacturers specifications can be used to look up the net PR?
- 10.10 What are some of the tools needed to perform an irrigation audit?
- 10.11 True or false: A site inspection and evaluation should be performed prior to any system testing?
- 10.12 What is the minimum number of catch cans that should be used to perform an irrigation system test?

Section 8:
**IRRIGATION
SCHEDULING**

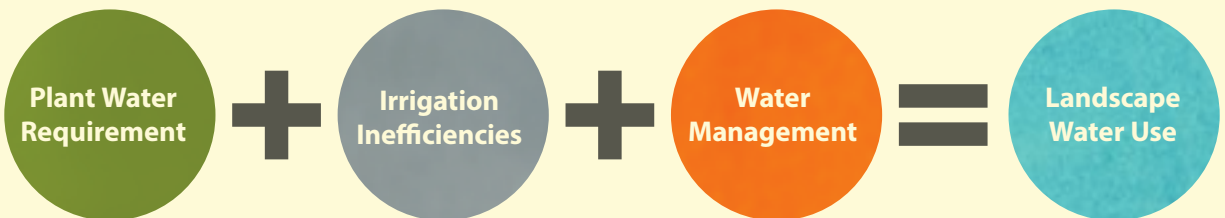



IRRIGATION SCHEDULING

Learning Objectives

1. Understand the concept of irrigation scheduling
2. Know how to determine irrigation run time
3. Know how to develop an irrigation schedule
4. Tools to assist with monitoring and adjustment

1 IRRIGATION SCHEDULING CONCEPT

- 1.1 It is important to understand irrigation scheduling in order to program both conventional and smart controllers.
- **Weather based irrigation controllers** (WBIC) aim to manage the application of landscape water by automatically adjusting the irrigation schedule to closely match changes in ETo based on site specific conditions.
 - In order to effectively program a WBIC, it is necessary to have an understanding of how an irrigation schedule for a conventional controller is determined.
- 1.2 Irrigation scheduling is **not an exact science**.
- The calculations used to determine an irrigation schedule provide a starting point for the water manager.
 - Schedules may need to be modified depending on observed results.
- 1.3 When preparing an irrigation schedule the water manager is required to make decisions about various elements, including:
- How long to irrigate each zone (**station run time**).
 - If runoff occurs, it may be necessary to split the run time to allow the water applied to infiltrate into the soil (**cycle and soak**).
 - What time of day to operate the irrigation system (**cycle start time**).
 - How many days each week to operate the irrigation system (**frequency of irrigation**).
 - Different types of plant material have different water requirements and root depths, and thus require separate irrigation **programs**.
- 1.4 Irrigation scheduling involves **water management** and is one of the three primary elements of saving water in the landscape (Figure 8-1).
- Water management in the landscape involves the management of water as a **resource** in order to optimize the beneficial use of the water to the plants in the landscape.
 - Water management refers to the need to actively oversee landscape irrigation and plant health in order to fully realize water savings potential and a successful landscape.

Figure 8-1: Elements of landscape water use



- Figure 8-2 shows a chart of weekly ETo for the months of March to October (gray line) using average weekly ETo for CIMIS station 83 in Santa Rosa (zone 5) for the period 1990 to 2015.
 - The orange line represents a typical residential irrigation pattern.
 - The yellow area represents under irrigation and blue represents over irrigation.
- The goal of the water manager is to irrigate in line with changes in ETo.

Figure 8-2: Weekly ETo for CIMIS station 83 in Santa Rosa vs. typical residential irrigation

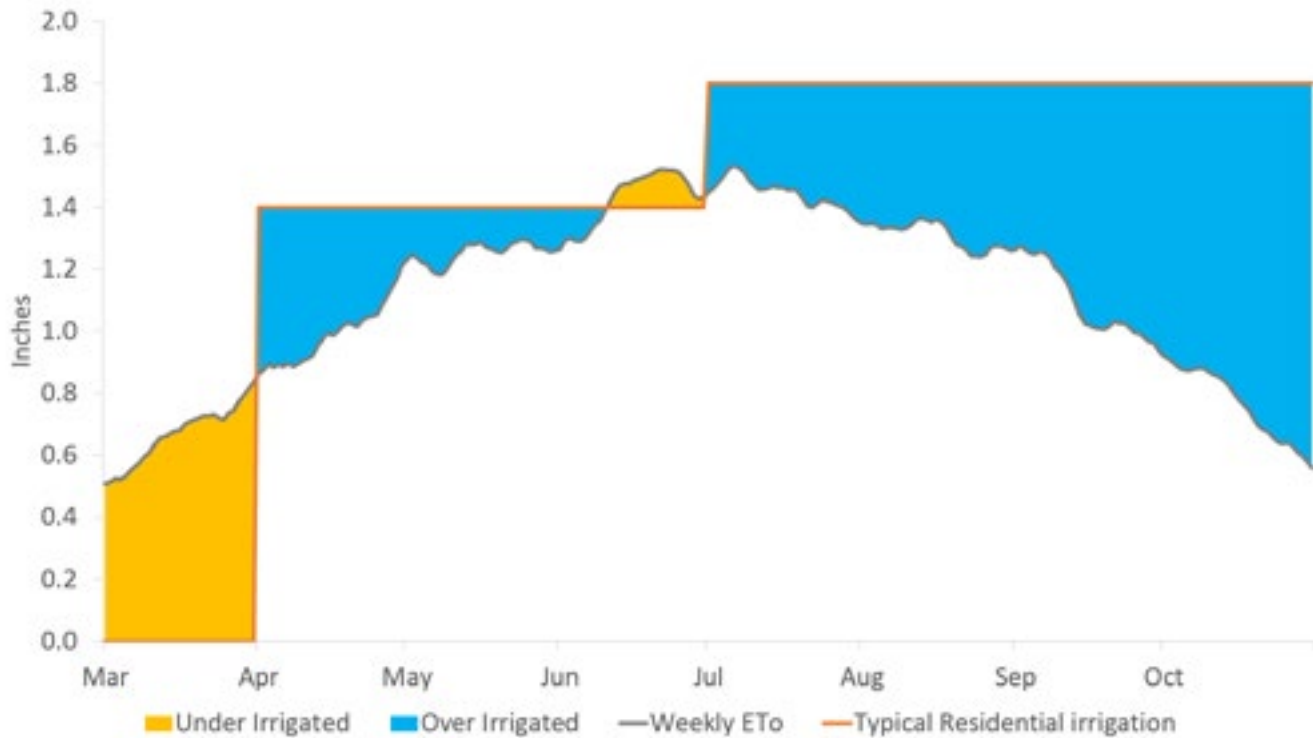

1.5 Remember the [soil moisture reservoir](#) from Section 3 (Figure 8-3)!

- The goal of the water manager is to maintain soil moisture [below field capacity](#), but [above permanent wilting point](#).
- The concept of [management allowable depletion](#) (MAD) determines how much the water manager allows soil moisture to be depleted before refilling the reservoir by irrigating.
- In order to irrigate the root zone properly, the water manager must know the [root depth](#) of the plants within the hydrozone.
 - Plants with shallow roots require more frequent irrigation with less total run time, e.g. turfgrass.
 - Plants with deep roots require less frequent irrigation with longer total run times, e.g. established perennials and woody plants.
 - In order to achieve the required total run time, the use of multiple start times (cycle and soak) may be needed in order to minimize water waste due to run off.
 - Irrigation should replenish moisture in the soil root zone.
- As noted in Section 3, [soil type](#) also plays an important role in irrigation scheduling.
 - For sandy soils, use shorter run times to prevent water draining beyond the root zone and more frequent water days due to lower water holding capacity.
 - For clay soils, use a lower application rate to prevent runoff, multiple start times to give water time to move through the root zone and allow time for air to return to the soil, and less frequent water days due to higher water holding capacity.
- Programmed and installed correctly WBICs are able to automatically adjust the irrigation schedule to water only when soil moisture reaches the MAD threshold.
- Conventional controllers require manual adjustment to deliver sufficient water to the landscape to replace water lost to ETo.

Figure 8-3: The soil moisture reservoir

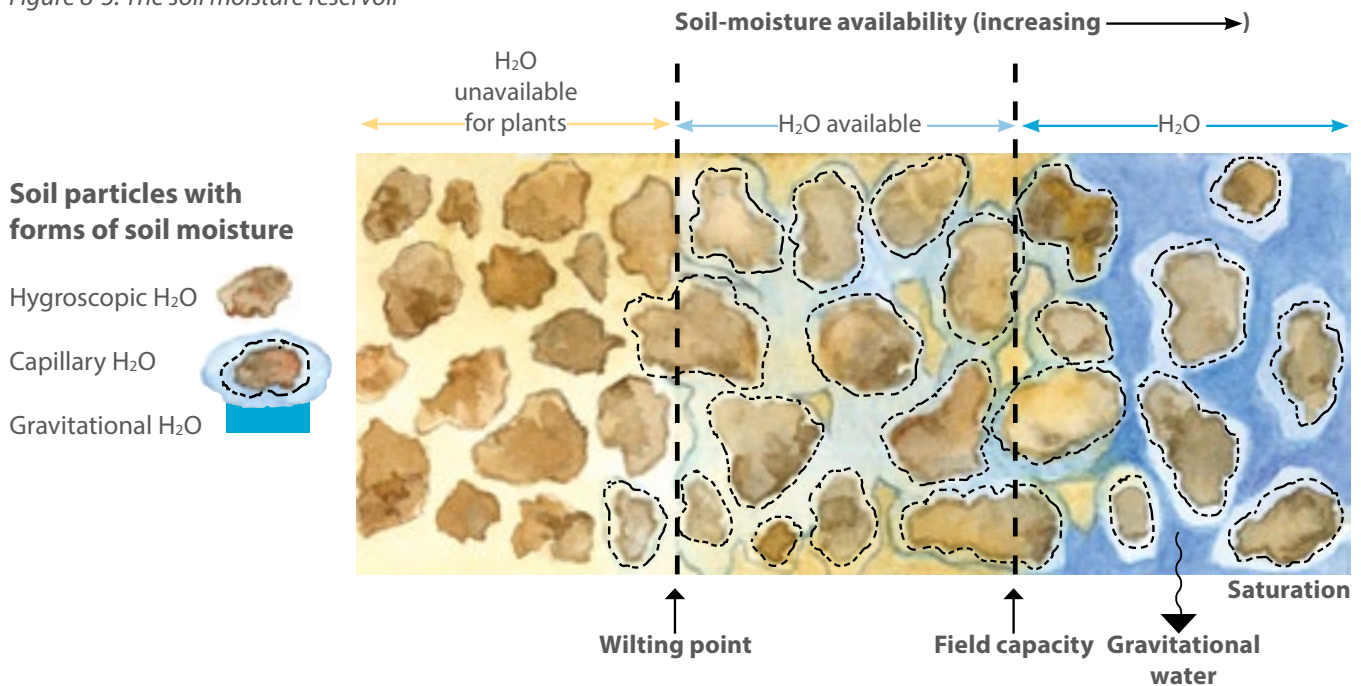

2 IRRIGATION RUN TIME

- 2.1 The first step to developing an irrigation schedule is to understand how much water the plants in the landscape need. Multiply ETo by the plant factor (PF) to determine the **plant water requirement** (PWR) in inches.
- Choosing daily, weekly, or monthly ETo will determine whether you calculate a daily, weekly, or monthly run time.
 - Most conventional irrigation controllers operate on a weekly schedule, so it might be most useful to determine the weekly run time.

$$\text{PWR} = \text{Weather} \times \text{Plant Type}$$

$$\text{PWR} = \text{ETo} \times \text{PF}$$

- 2.2 The **run time multiplier** (RTM) is calculated using the DU_{LQ} determined during an irrigation audit in order to adjust for irrigation system inefficiencies. The RTM is used to determine the maximum amount of water to apply to the hydrozone to maintain plant health given that the irrigation system does not deliver water in a perfectly uniform manner. The RTM results in a lower maximum amount of water than simply dividing by DU_{LQ} to reflect that there is lateral movement of water in the soil.

$$\text{RTM} = 1 \div [0.4 + (0.6 \times DU_{LQ})]$$

- 2.3 Multiply the PWR by the RTM to calculate the **irrigation water requirement** (IWR) in inches.

$$\text{IWR} = \text{PWR} \times \text{RTM}$$

- 2.4 The PWR and IWR are measured in inches and provide **minimum** and **maximum** amounts of water to be applied to the hydrozone to maintain plant health.
- The water manager should generally apply water within this range.
 - Irrigating closer to the PWR may result in some stress to the plants in the hydrozone.
 - Irrigating closer to the IWR should provide adequate water for healthy plant growth and account for irrigation system inefficiencies.
- 2.5 Determine minimum and maximum irrigation run times to translate the PWR and IWR from inches into minutes.
- The **minimum irrigation run time** (IRT_{MIN}) is determined by dividing the PWR by the precipitation rate (PR) determined in an irrigation audit, multiply by 60 to convert to minutes.

$$IRT_{MIN} = (PWR \div PR) \times 60$$

- The **maximum irrigation run time** (IRT_{MAX}) is determined by dividing the IWR by the precipitation rate (PR) determined in an irrigation audit, multiply by 60 to convert to minutes.

$$IRT_{MAX} = (IWR \div PR) \times 60$$

2.6 Table 8-1 shows example **weekly IRT** for CIMIS Zone 5 for the typical irrigation season in California from April to October.

Table 8-1: Example weekly irrigation run times

Plant Type			Low Water Use Shrubs	Moderate Shrubs	Cool Season Turf	Cool Season Turf
Irrigation Type			Inline Drip	Inline Drip	Rotating Sprinklers	Fixed Spray Sprinklers
PF, DU _{LQ} & PR			PF 0.3, DU 0.9, PR 0.5 in / hr	PF 0.5, DU 0.9, PR 0.5 in / hr	PF 0.8, DU 0.7, PR 0.5 in / hr	PF 0.8, DU 0.6, PR 1.5 in / hr
Month	Monthly ETo (inches)	Weekly ETo (inches)	Weekly IRT_{MIN} / IRT_{MAX} (minutes)			
Apr	4.20	0.98	35 / 38	59 / 63	94 / 115	31 / 41
May	5.58	1.26	45 / 48	76 / 80	121 / 148	40 / 53
Jun	6.30	1.47	53 / 56	88 / 94	141 / 172	47 / 62
Jul	6.51	1.47	53 / 56	88 / 94	141 / 172	47 / 62
Aug	5.89	1.33	48 / 51	80 / 85	128 / 156	43 / 56
Sep	4.50	1.05	38 / 40	63 / 67	101 / 123	34 / 44
Oct	3.10	0.7	25 / 27	42 / 45	67 / 82	22 / 29

- Weekly run times are shown for four different hydrozones ranging from low water use shrubs irrigated with inline drip, to cool season turf irrigated with fixed spray sprinklers.
- The two numbers shown for each weekly run time are the minimum and maximum IRT in minutes.

- The difference between the minimum and maximum IRT is typically only a few minutes if the DU_{LQ} is relatively high since the RTM is close to 1.
- The difference between the minimum and maximum IRT is larger when the DU_{LQ} is relatively low and when the application rate is relatively low (as much as 30 mins in the examples provided).
- July is the peak watering month:
 - Low water use shrubs with inline drip 53 to 56 mins per week.
 - Moderate shrubs with inline drip 88 to 94 minutes per week.
 - Cool season turf with rotating sprinklers 141 to 172 mins per week.
 - Cool season turf with fixed spray sprinklers 47 to 62 mins per week.

3 IRRIGATION SCHEDULING

3.1 In order to use the IRT calculated to program the irrigation controller, it is necessary to determine:

- How many days to water.
- How long to water each day.
- How many start times to use.
- At what time of day to irrigate.

3.2 In order to make these decisions, the water manager must understand the limitations of the controller as well as the requirements of the landscape plants.

- How long does it take before runoff occurs?
- How many start times and programs does the controller have available?
- Is it possible to run more than one program at a time and does the irrigation system have sufficient pressure to run more than one valve at a time?
- Does the controller have a cycle and soak option?
- How deep are the plants roots in each hydrozone?
- What is the infiltration rate of the soil?
- If using overhead spray, avoid irrigating when it is typically windy and during the heat of the day in order to avoid water loss to evaporation.

3.3 Table 8-2 provides general recommendations for the **number of days** per week to irrigate for mature plants. The number of days to water is a management decision that must be made by the water manager and is a function of many factors such as:

- Desired appearance of the plants in the hydrozone.
- Drought tolerance and preferred soil moisture content of the plants in the hydrozone.
- Root depth of the plant material, which is likely to be a function of soil type and condition.
- Available watering window.

Table 8-2: Recommended number of days to irrigate for mature plants

Plant Type	Cool Weather (ETo up to 0.5-in/wk)	Warm Weather (ETo 0.6-1.0-in/wk)	Hot Weather (ETo above 1-in/wk)
Turfgrass	1 – 2 days	2 – 3 days	3 – 7 days
Annuals	2 – 3 days	3 – 5 days	4 – 7 days
Perennials & Shrubs	Every 2 weeks	Every week	2 – 4 days
Trees	None	Every 2 months	Every month

3.4 Table 8-3 shows an example of number of days to irrigate for the same four hydrozones shown in Table 8-1.

Table 8-3: Example number of days to irrigate

Plant Type			Low Water Use Shrubs	Moderate Shrubs	Cool Season Turf	Cool Season Turf
Irrigation Type			Inline Drip	Inline Drip	Rotating Sprinklers	Fixed Spray Sprinklers
PF, DU _{LQ} , & PR			PF 0.3, DU 0.9, PR 0.5 in / hr	PF 0.5, DU 0.9, PR 0.5 in / hr	PF 0.8, DU 0.7, PR 0.5 in / hr	PF 0.8, DU 0.6, PR 1.5 in / hr
Month	Monthly ETo (inches)	Weekly ETo (inches)	Number of Days Per Week to Irrigate			
Apr	4.20	0.98	1	1	2	3
May	5.58	1.26	1	2	3	3
Jun	6.30	1.47	1	2	4	4
Jul	6.51	1.47	1	2	4	4
Aug	5.89	1.33	1	2	3	3
Sep	4.50	1.05	1	2	2	3
Oct	3.10	0.7	1	1	2	2

- It is assumed that the irrigation controller operates with a weekly schedule, so the minimum irrigation frequency possible is once per week.
 - Some controllers do not have this limitation. A monthly schedule allows for less frequent irrigation cycles and a deeper application of water. For large established plants and trees, this encourages deeper root establishment and therefore a healthier plant or tree.
- The frequency for the low water use shrubs is selected as one day per week for all months from April to October.
 - The ideal frequency for the low water use plants may well be once every two weeks or less if the controller were capable of such a schedule.
- The frequency for the moderate shrubs is selected as one day per week in April and October and two days per week during the hotter months.
- The frequency for the cool season turfgrass is selected as two days per week in October, three days in April, May, August, and September, and four days in the hottest months of June and July.

3.5 Having decided how many days to irrigate each week, divide the weekly IRT by the number of days to irrigate to determine the daily IRT.

Daily IRT = Weekly IRT ÷ Number of Days to Irrigate

3.6 Table 8-4 shows an example of **daily IRT** based on the number of days to irrigate in Table 8-3.

Table 8-4: Example daily run time

Plant Type			Low Water Use Shrubs	Moderate Shrubs	Cool Season Turf	Cool Season Turf
Irrigation Type			Inline Drip	Inline Drip	Rotating Sprinklers	Fixed Spray Sprinklers
PF, DU _{LQ} , & PR			PF 0.3, DU 0.9, PR 0.5 in / hr	PF 0.5, DU 0.9, PR 0.5 in / hr	PF 0.8, DU 0.7, PR 0.5 in / hr	PF 0.8, DU 0.6, PR 1.5 in / hr
Month	Monthly ETo (inches)	Weekly ETo (inches)	Daily IRT _{MIN} / IRT _{MAX} (minutes)			
Apr	4.20	0.98	35 / 38	59 / 63	47 / 58	11 / 14
May	5.58	1.26	45 / 48	38 / 40	41 / 50	14 / 18
Jun	6.30	1.47	53 / 56	44 / 47	36 / 43	12 / 16
Jul	6.51	1.47	53 / 56	44 / 47	36 / 43	12 / 16
Aug	5.89	1.33	48 / 51	40 / 43	43 / 52	15 / 19
Sep	4.50	1.05	38 / 40	32 / 34	51 / 62	12 / 15
Oct	3.10	0.7	25 / 27	42 / 45	34 / 41	11 / 15

- When calculating daily IRT, it might be necessary to go back and adjust the number of days to irrigate if the run times are excessively long or short.
- Daily IRT for the four hydrozones in the peak watering month of July are:
 - Low water use shrubs with inline drip 53 to 56 mins, once per week.
 - Moderate shrubs with inline drip 44 to 47 minutes, twice per week.
 - Cool season turf with rotating sprinklers 36 to 43 mins, four times per week.
 - Cool season turf with fixed spray sprinklers 12 to 16 mins, four times per week.

3.7 Divide the daily IRT by the time to runoff, to determine the number of irrigation cycles required each day. Round up to the next whole number.

$$\text{Cycles per Day} = \text{Daily IRT} \div \text{Time to Runoff}$$

3.8 Table 8-5 shows an example of the **number of irrigation cycles per day** required to irrigate the daily IRT values in Table 8-4, subject to the indicated **time to runoff**.

Table 8-5: Example number of irrigation cycles per day

Plant Type		Low Water Use Shrubs	Moderate Shrubs	Cool Season Turf	Cool Season Turf	
Irrigation Type		Inline Drip	Inline Drip	Rotating Sprinklers	Fixed Spray Sprinklers	
PF, DU _{LQ'} & PR		PF 0.3, DU 0.9, PR 0.5 in / hr	PF 0.5, DU 0.9, PR 0.5 in / hr	PF 0.8, DU 0.7, PR 0.5 in / hr	PF 0.8, DU 0.6, PR 1.5 in / hr	
Time to Runoff		30	30	30	5	
Month	Monthly ETo (inches)	Weekly ETo (inches)	Min / Max Cycles Per Day			
Apr	4.20	0.98	2 / 2	2 / 3	2 / 2	3 / 3
May	5.58	1.26	2 / 2	2 / 2	2 / 2	3 / 4
Jun	6.30	1.47	2 / 2	2 / 2	2 / 2	3 / 4
Jul	6.51	1.47	2 / 2	2 / 2	2 / 2	3 / 4
Aug	5.89	1.33	2 / 2	2 / 2	2 / 2	3 / 4
Sep	4.50	1.05	2 / 2	2 / 2	2 / 3	3 / 3
Oct	3.10	0.7	1 / 1	2 / 2	2 / 2	3 / 3

- In most cases in this example, two irrigation cycles are required to irrigate each hydrozone.
- The number of cycles required for the cool season turf irrigated with fixed spray sprinklers is three to four cycles due to the short time to runoff of five mins.
- The water manager should leave sufficient time between cycles for the water applied to infiltrate into the soil.
- If there are more cycles than the irrigation controller is capable of then the water manager will need to adjust the number of days to irrigate and daily IRT of the schedule.
 - Alternatives to overcome the number of start times available on the controller and ensure that water reaches the desired root depth, include cycle and soak (if available), or using two programs to double the number of start times.

3.9 Divide the daily IRT by the number of cycles per day to determine the run time per cycle. Round up to the next whole minute.

Run Time Per Cycle = Daily IRT ÷ Cycles per Day

3.10 Table 8-6 shows an example of **run time per cycle** based on the number of irrigation cycles per day in Table 8-5.

- It is important to sense check the run time per cycle numbers, e.g. a rotor may take several minutes to rotate a full circle.

Table 8-6: Example run time per cycle

Plant Type			Low Water Use Shrubs	Moderate Shrubs	Cool Season Turf	Cool Season Turf
Irrigation Type			Inline Drip	Inline Drip	Rotating Sprinklers	Fixed Spray Sprinklers
PF, DU _{LQ'} & PR			PF 0.3, DU 0.9, PR 0.5 in / hr	PF 0.5, DU 0.9, PR 0.5 in / hr	PF 0.8, DU 0.7, PR 0.5 in / hr	PF 0.8, DU 0.6, PR 1.5 in / hr
Month	Monthly ETo (inches)	Weekly ETo (inches)	Min / Max Run Time per Cycle (minutes)			
Apr	4.20	0.98	18 / 19	30 / 21	24 / 29	4 / 5
May	5.58	1.26	23 / 24	19 / 20	21 / 25	5 / 5
Jun	6.30	1.47	27 / 28	22 / 24	18 / 22	4 / 4
Jul	6.51	1.47	27 / 28	22 / 24	18 / 22	4 / 4
Aug	5.89	1.33	24 / 26	20 / 22	22 / 26	5 / 5
Sep	4.50	1.05	19 / 20	16 / 17	26 / 21	4 / 5
Oct	3.10	0.7	25 / 27	21 / 23	17 / 21	4 / 5

- Run times per cycle for the four hydrozones in the peak watering month of July are:
 - Low water use shrubs with inline drip 27 to 28 mins, two cycles, once per week.
 - Moderate shrubs with inline drip 22 to 24 minutes, two cycles, twice per week.
 - Cool season turf with rotating sprinklers 18 to 22 mins, two cycles, four times per week.
 - Cool season turf with fixed spray sprinklers 4 mins, three to four cycles, four times per week.

3.11 The final piece of the irrigation scheduling puzzle is to select the appropriate **start times**, **days to irrigate**, and **program** for each hydrozone.

- Typically hydrozones that require the same number of days to irrigate and number of irrigation cycles per day, can reside on the same irrigation program.
- In the example used throughout this section, four irrigation programs could be used using multiple start times for each hydrozone.
- Alternatively, three programs could be used by putting the two turf zones on one program and using cycle and soak as an alternative to multiple start times.

- The start time and days to irrigate should be selected by the water manager in agreement with the owner or user of the landscape.
 - Overhead spray is typically best to operate just before or around sunrise when winds tend to be lower, and the atmosphere and soil surface are cooler to minimize water loss to evaporation.
 - Care should be taken not to operate overhead spray when it is excessively windy.
- Check local watering restrictions.

3.12 Once the irrigation schedule is in operation, it is an essential component of water management to **continually monitor** each hydrozone and to make necessary **adjustments** over time.

- Monitor the soil moisture at the appropriate root depth for each hydrozone.
- Reduce run times if soil appears excessively moist and to limit excessive vegetative growth.
- Increase run times if soil appears excessively dry or if plants are showing signs of drought stress.
- Figure 8-4 displays the steps explained above as a continuous cycle.

Figure 8-4: Irrigation scheduling cycle

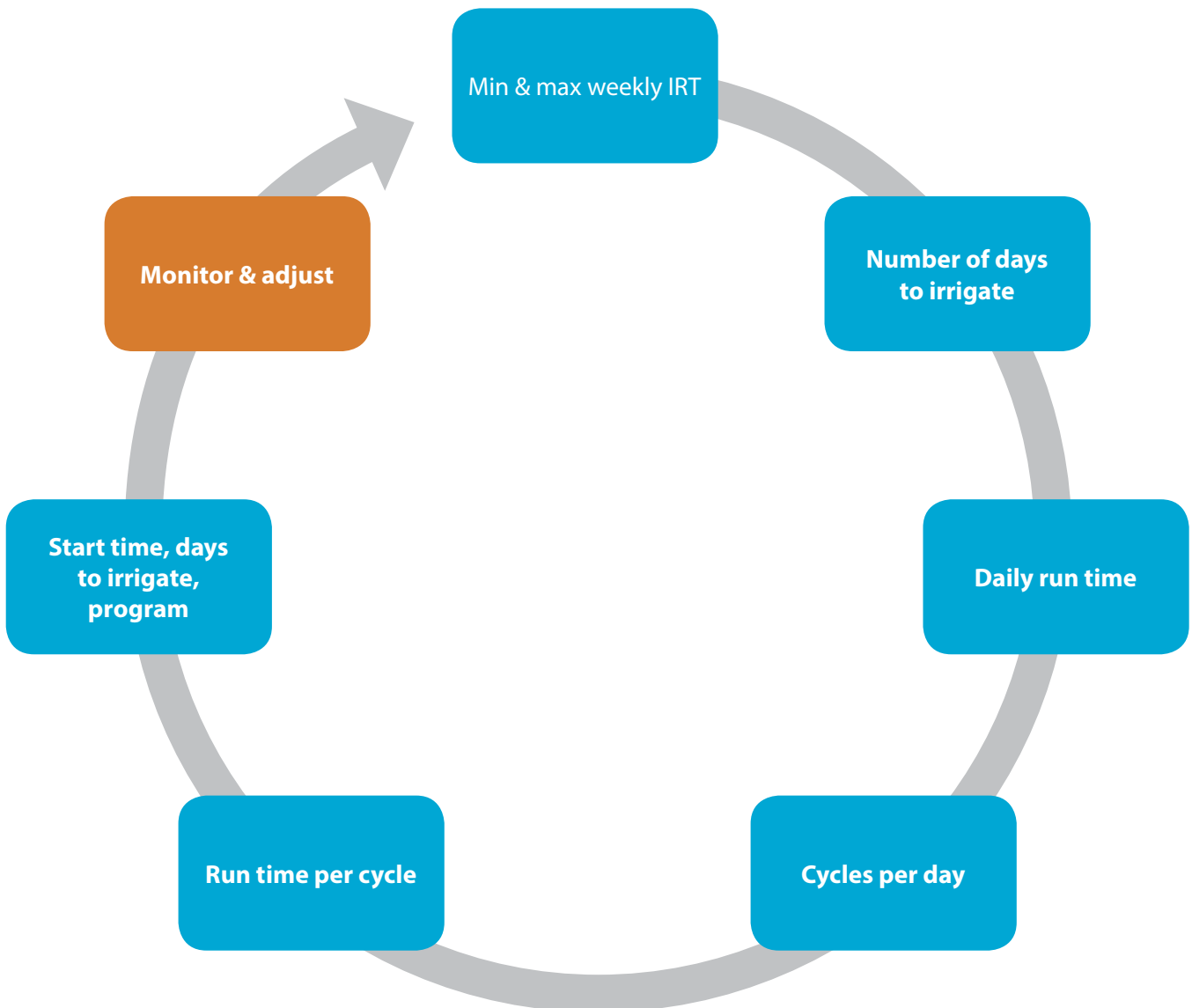

4 TOOLS TO ASSIST THE WATER MANAGER WITH MONITORING AND ADJUSTMENT

- 4.1 Regardless of the technology that is in place, there really is no substitute for the **expertise** and **observation** of the water manager. Being able to identify saturated soils or drought stressed plants are skills that are difficult to replace with automation and technology.
- 4.2 Remember the **soil probe!**
- The soil probe is perhaps the easiest method of determining what's happening beneath the soil surface.
 - Check soil moisture.
 - Check the depth of soil moisture.
 - Check root depth of plants.
- 4.3 **Weather based irrigation controllers** (WBIC) have the ability to adapt to changing weather conditions much more rapidly than conventional controllers and can save the water manager a considerable amount of time.
- **EPA WaterSense labeled irrigation controllers**¹ have been independently certified to ensure that they can adequately meet the watering needs of a landscape without overwatering.
 - WBICs require carefully programming and ongoing monitoring in order to operate properly.
 - With proper programming WBICs can provide a significant return on investment due to the **water** and **time savings** that they can provide.
- 4.4 Sensors for irrigation controllers interrupt the irrigation schedule in response to specific site conditions.
- Sensors are covered in detail in Section 9, Irrigation Controllers.
- 4.5 Local water utilities often publish watering schedules that can be a great starting point for developing an irrigation schedule.



¹<https://www3.epa.gov/watersense/products/controltech.html>

5 IRRIGATION SCHEDULING REVIEW QUESTIONS

- 5.1 What are some of the decisions that the water manager needs to make when developing an irrigation schedule for a conventional controller.
- 5.2 What are the three methods of saving water in the landscape?
- 5.3 Using the concept of the soil moisture reservoir explain what the water manager is trying to achieve when managing water in the landscape.
- 5.4 What is the relationship between root depth and developing an irrigation schedule?
- 5.5 How is the plant water requirement calculated using ETo and the plant factor?
- 5.6 What does the run time multiplier do?
- 5.7 What is the difference between the plant water requirement (lower boundary) and the irrigation water requirement (upper boundary)?
- 5.8 What is the daily run time if the weekly run time is 30 minutes and irrigation will occur 2 days per week?
- 5.9 How many cycles per day are required if the daily run time is 15 minutes and the time to runoff is 5 minutes?
- 5.10 What is the run time per cycle if the daily run time is 15 minutes and the number of cycles per day is 3?
- 5.11 Name a few important considerations regarding the time of day to operate overhead irrigation.
- 5.12 What is the most important aspect of irrigation scheduling? Hint: continually monitor and adjust.
- 5.13 What tools are available to the water manager to assist with monitoring and adjustment of the irrigation schedule.

Section 9:
**IRRIGATION
CONTROLLERS**





IRRIGATION CONTROLLERS

Learning Objectives

1. Understand the function of an irrigation controller
2. Understand the various types of irrigation controllers
3. Understand the parameters required to program a conventional controller
4. Programming a conventional controller
5. Understand how a weather based irrigation controller works
6. Using sensors to improve irrigation efficiency

1 IRRIGATION CONTROLLERS

- 1.1 The primary function of an irrigation controller is to [control the operation of electric irrigation valves](#) and the delivery of water to the landscape.
- 1.2 If used properly, irrigation controllers can [efficiently manage the application of irrigation water](#) and provide [reliable operation of irrigation systems](#) at any time of day or night.

2 IRRIGATION CONTROLLER TYPES

- 2.1 Irrigation controller manufacturers produce a variety of products designed to meet specific needs.
- 2.2 Controllers might be available in either [indoor](#) or [outdoor](#) configurations.
 - Indoor controllers have an external plug-in power supply that transforms the electrical input from 120 volts down to 24 volts.
 - Outdoor controllers have an internal power supply and are hard-wired. Outdoor controllers are typically installed in a weatherproof enclosure that can be locked.
- 2.3 Controllers are often specified to as [residential](#) or [commercial](#).
 - Residential controllers are specified for common residential applications. They typically have fewer stations than commercial controllers and a more basic feature set with the emphasis on being relatively easy to use.
 - Residential and light commercial controllers often come in both indoor and outdoor models.
 - Commercial controllers are specified for larger sites and typically include more advanced features such as more programs and start times, remote control, electronic troubleshooting options, and flow alert monitoring.
 - Commercial controllers are typically specified for outdoor installation.
- 2.4 The term [standalone controller](#) is used to describe a conventional controller that operates on a fixed irrigation schedule.
 - A variety of sensors can be used to improve the efficiency and performance of standalone controllers.
 - Most modern controllers have [non-volatile memory](#), so programming will remain in the controller in the event of a loss of power. However, many older models rely on a battery backup to retain the programming if power is lost.
 - For controllers that rely on battery backup, a battery replacement schedule is necessary to ensure optimum memory performance.
 - It is recommended that the battery be changed at least every other year.
- 2.5 [Weather based irrigation controllers](#) (WBICs) use local weather, landscape conditions, and type of irrigation equipment to tailor watering schedules to actual conditions on the site.
 - Some conventional controllers can be upgraded to WBICs with the addition of a module and/or sensor.
 - Weather data may be from an on-site weather station or from an off-site source of weather data.
 - Weather data may be subscription based or free.

- Some WBICs also have historical average weather data stored onboard that can be used in the event that current data is unavailable.

2.6 **Soil moisture-based controllers** use soil moisture sensors to measure soil moisture within the root zone and shut off the irrigation system when the desired soil moisture level has been reached.

- Soil moisture-based controllers do not rely on weather data to operate.
- The controller compares soil moisture readings to the desired moisture level for the soil type, plant type, and other landscape variables programmed into the controller.
- If the amount of moisture measured in the root zone meets or exceeds the target level, the controller overrides the irrigation system. If the amount of moisture measured in the root zone is less than the target level, the controller allows the system to operate as programmed.

2.7 The term **WiFi irrigation controller** is used to describe irrigation controllers that can be connected to a WiFi network.

- WiFi irrigation controllers can be controlled remotely from a web browser or dedicated application.
- Many WiFi irrigation controllers are also WBICs.



2.8 For large commercial installations, **central control** enables the control of a network of compatible irrigation controllers through one central system.

- Central control systems can be used to manage multiple sites and controllers remotely.
- Remote operation can be used to program, monitor, and operate the network of connected controllers.
- Central control compatible controllers can be linked to the system by a variety of methods including hard wiring, radio, cellular, local area network (LAN), and WiFi.

2.9 Irrigation controllers can have **conventional wiring** or **two-wire systems**.

- Conventional wiring uses one common wire and a hot wire for each irrigation valve.
- Two-wire uses only two wires combined with a decoder. Two-wire systems are used for large commercial and residential systems or phased installations where the cost savings in wire and other advantages can be significant.

3 CONVENTIONAL IRRIGATION CONTROLLER PARAMETERS

Figure 9-1: Left to right (1) Hunter Pro-C, (2) Irritrol Rain Dial-R, (3) Rain Bird ESP-ME, (4) Toro Evolution (images courtesy of Hunter Industries Inc, Irritrol, Rain Bird Corporation, and The Toro Company)



3.1 **Programs** are separate irrigation schedules to allow the water manager to group hydrozones with similar irrigation requirements together; e.g. program A for turf zones, program B for shrub zones, and program C for trees.

- Each program will irrigate all of the zones selected to run on the same days of the week and with the same number of cycles.
- Hydrozones are grouped together in the same program based on factors such as:
 - Water requirements of the plant material
 - Root depth
 - Microclimate (sun, shade, wind, heat)
 - Soil type
 - Irrigation emission device application rates
 - Time to runoff
 - Other factors such as convenience and constraints of the controller

3.2 **Start time** is the time of day that a given program will commence.

- **Multiple start times** help prevent runoff by splitting the total run time into shorter run times. Multiple start times are also useful for keeping newly planted plant material moist during establishment, and for allowing water to penetrate deeper into the root zone.
- **Cycle and soak** is an alternative to multiple start times. The cycle time and soak period are specified, and the controller determines the total number of cycles by dividing the total run time by the cycle time.

3.3 **Run time** is the length of time that the controller will run the individual valves for each program start time. A separate run time is entered for each station on the controller.

- The program run time should be less than the **observed time to runoff**. Multiple start times can be used to make up the entire irrigation run time.

- 3.4 **Water days** are the days of the week that the controller will run the program. There are several commonly used approaches to water days:
- **Specific days** – the water manager can select specific days of the week to run the irrigation program.
 - **Odd/even days** – the water manager can select either odd or even days to run the irrigation program.
 - **Interval watering** – the water manager can select the interval in days between irrigation cycles for the program. This feature works well for low water use plants and trees that require watering less than once a week.
- 3.5 **Seasonal adjustment** – is a global percentage adjustment that adjusts all or selected programs and run times in the controller.
- Figure 9-2 shows an example of a typical seasonal adjustment by month for CIMIS Zone 5. Irrigation would not normally be required in the winter months due to precipitation, cool weather, and plant dormancy.
 - This setting can save the water manager a significant amount of time when reprogramming controllers through the season.
 - The run time should be entered for the **hottest month** of the year so that the seasonal adjustment can be used to reduce run times during the year.

Figure 9-2: CIMIS Zone 5 seasonal adjustment

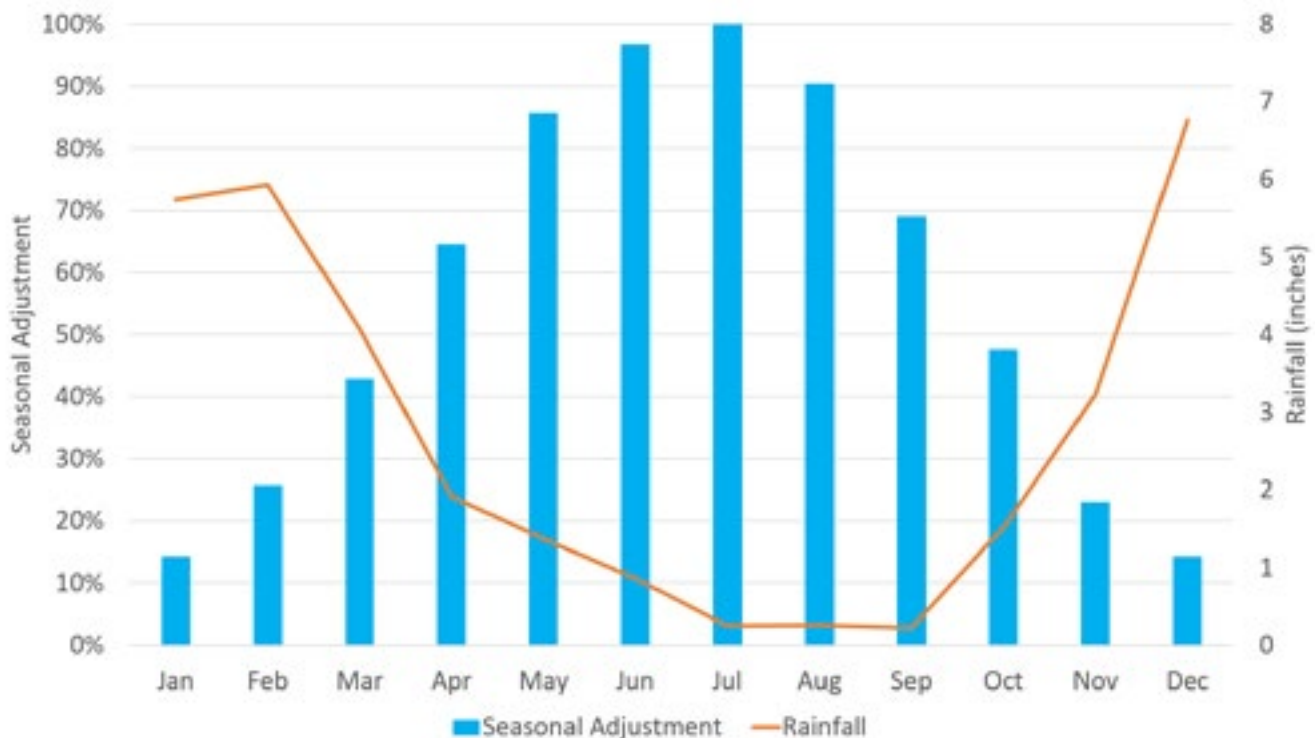

4 PROGRAMMING A CONVENTIONAL CONTROLLER

4.1 Program the following peak month irrigation schedule into a conventional controller.

Table 9-1: Example irrigation schedule

Plant Type	Low Water Use Shrubs	Moderate Shrubs	Cool Season Turf	Cool Season Turf
Irrigation Type	Inline Drip	Inline Drip	Rotating Sprinklers	Fixed Spray Sprinklers
Station	1	2	3	4
Program	A	B	C	D
Start Times	6 a.m., 8 a.m.	7 a.m., 9 a.m.	4 a.m., 5 a.m.	4 a.m., 4:30 a.m., 5 a.m., 5:30 a.m.
Run Time	28	24	20	4
Water Days	Su	We, Sa	Odd	Even
Weekly Run Time	56	96	140	56

4.2 Considerations

- Is the controller capable of multiple start times and/or cycle and soak? If the controller does not offer these basic features, consider upgrading it.
- Does the controller have 4 programs available? Many controllers are limited to 3 programs.
- Does the controller allow a monthly or bi-monthly irrigation schedule using interval programming? Trees on a separate hydrozone may benefit from monthly or bi-monthly irrigation cycles.
- If there are insufficient programs to input the desired schedule, the water manager must look for alternatives or adjust the schedule.
- One solution for the irrigation schedule above is to combine stations 3 and 4 onto one program if a cycle and soak feature is available.
 - Both stations would need to run on the same days.
 - Station 3 would have a run time of 40 mins, a cycle time of 20 mins, and an appropriate soak time (e.g. 15 – 30 mins).
 - Station 4 would have a run time of 16 mins, a cycle time of 4 mins, and an appropriate soak time (e.g. 15 – 30 mins).
- A second solution would be to combine stations 1 and 2 onto one program. This would require changing the schedule of one station to have the same watering days as the other.
 - Station 1 could be changed to have a run time of 14 mins with 2 start times and run on the same two days as station 2.

4.3 Hunter X-Core Controller (Figure 9-3)

- Set the time and day.
 - Turn dial to current time/day.
 - Use + and - buttons to change year, month, day, and time.
 - Progress using the ► button.
- Set the program start times.
 - Turn dial to start times.
 - Use PRG button to select program A, B, or C.
 - Use + and - buttons to change start time (15 min increments).
 - Add additional start times using the ► button.
 - Up to 4 start times can be used for each program.
- Set station run times.
 - Turn dial to run times.
 - Use PRG button to select program A, B, or C.
 - Use + and - buttons to change the station run time.
 - Use the ► button to progress to the next station.
- Set watering days.
 - Turn dial to water days position.
 - Use PRG button to select program A, B, or C.
 - Use + and - buttons to toggle watering on or off for each day of the week. The cursor automatically moves to the next day.
 - Odd / even watering days can be used as an alternative to specific days. With the cursor on SU press the ► button. Use the + and - buttons to select odd or even watering days.
 - Interval watering can be used as an alternative to specific days or odd / even watering days. With the cursor on odd / even press the ► button. Use the + and - buttons to select the number of days between watering (1 – 31 days).
 - Turn dial to the run position.
- Seasonal adjustment.
 - Turn dial to seasonal adjustment.
 - Use + and - buttons to adjust percentage in 10% increments.
 - Note: adjusted run times will be displayed. Return seasonal adjustment to 100% to program run times.
- Cycle and Soak (hidden feature)
 - Turn dial to run.
 - Press and hold the + button for 3 seconds.
 - While holding the + button turn dial to run times.
 - Use the ◀ and ▶ buttons to select the station.
 - Use the + and - buttons to set the cycle time.

Figure 9-3: Hunter X-Core controller (image courtesy of Hunter Industries Inc)



- Press the PRG button to access the soak menu.
- Use the ◀ and ▶ buttons to select the station.
- Use the + and - buttons to set the soak time.

4.4 Irritrol Rain Dial (Figure 9-4)

- Set function switch to set programs.
 - Turn dial to current time.
 - Use + and - buttons to set correct time.
 - Turn dial to Today.
 - Use + and - buttons to select correct day.
- Select program A, B, or C.
 - Turn dial to station number (1 – 12).
 - Use + and - buttons to set run time.
- Set program start times.
 - Turn dial to start time number (1 – 3).
 - Use + and - buttons to set start time.
 - Up to 3 start times can be used for each program.
- Set watering days.
 - Turn dial to desired day.
 - Use + and - buttons to turn day on or off.
 - Repeat for all days.
 - Skip days can be used to program an interval rather than using specific days (1 – 31 days).
- Seasonal adjustment.
 - Turn dial to skip days / special functions.
 - Press manual button twice (display should show 100).
 - Use the + and - buttons to set the desired percentage.
- Repeat for each program.
- Set dial to current time and function switch to run.

Figure 9-4: Irritrol Rain Dial controller (image courtesy of Irritrol)



5 WEATHER BASED IRRIGATION CONTROLLERS (WBICS)

5.1 Although all WBICs utilize evapotranspiration data to determine irrigation schedules, there can be significant differences in the parameters that need to be entered.

- Some WBICs require the water manager to enter a **peak month irrigation run time and frequency**. The WBIC uses rainfall and current weather data to adjust the frequency and run time of irrigation events according to the parameters entered.
 - This type of controller relies on the water manager to understand how to determine an effective irrigation schedule for each hydrozone, similar to a conventional controller.
- Other WBICs require the water manager to enter **field data** in order for the controller to perform the scheduling calculation. The data required might include: type of irrigation device, plant material, soil type, root depth, slope, and microclimate.
 - This type of controller uses assumptions derived from the **field data**, entered together with current weather conditions to generate an irrigation schedule. If the field data does not correspond to site conditions, the irrigation schedule will be inaccurate.
- Different controllers will generate different irrigation schedules due to differences in the assumptions used and differences in the ability to tailor those assumptions to match the landscape.
 - The water manager should understand the underlying assumptions used by the controller so that the irrigation schedule generated can be tuned to meet the watering needs of the landscape.

Figure 9-5: Left to right (1) Hunter Pro-HC, (2) Rain Bird ESP-LXME, (3) Toro Evolution, (4) Rachio (images courtesy of Hunter Industries, Rain Bird Corporation, The Toro Company, and Rachio, Inc)



5.2 There are two common approaches that WBICs use for watering frequency and run times. Both methods are based on the concept of **management allowable depletion (MAD)** with the goal of restoring the soil moisture reservoir to field capacity at each irrigation event.

- **Variable watering frequency with a fixed run time**. This means that the number of days between watering will change depending on evapotranspiration and rainfall.
- **Fixed watering frequency with a variable irrigation run time**. This means that the number of days between watering will correspond to the peak month irrigation frequency that has been programmed into the controller, but that the number of minutes that the irrigation program will run for will change depending on evapotranspiration and rainfall.

5.3 EPA WaterSense provides a list of [WaterSense labeled irrigation controllers](#).¹ These WBICs have been independently certified to ensure that they can adequately meet the watering needs of a landscape without overwatering.



5.4 [Smart Water Application Technologies](#) (SWAT)² is a coalition of water purveyors, equipment manufacturers, and irrigation practitioners that develops testing protocols and promotes water-efficient products including WBICs.



5.5 Potential issues with WBICs:

- The ability to properly program the controller to reflect site conditions depends on the flexibility of the controller and the expertise of the water manager.
- The ET data used might not properly match site conditions due to being from an offsite source that has a significantly different microclimate.
- Data source connection issues will result in the controller using historic ET data or the most recent information downloaded until the connection is restored.
- Where on-site ET data is used, sensors require proper setup and maintenance to function accurately.
- Close observation and system tuning is critical following initial installation and setup to ensure proper irrigation depth and frequency. This is especially true when establishing new plantings or when establishing the peak watering month irrigation schedule.

6 SENSORS FOR IRRIGATION CONTROLLERS

6.1 Sensors for irrigation controllers are devices [that interrupt the electrical signal](#) in response to [specific site conditions](#) and modify the operation of the irrigation controller. Sensors can save significant amounts of both time and water.

6.2 [ET](#) sensors can upgrade a standard controller to a WBIC. They are weather sensors that determine evapotranspiration and adjust the controller based on local weather conditions.

- ET sensors require a compatible controller.
- ET sensors typically incorporate rain and freeze sensors to shut down the irrigation system.

6.3 [Flow](#) sensors shut down the irrigation system when a specified level of overflow or underflow has occurred. Many flow sensing systems automatically send flow alerts to the water manager.

- Flow sensors can prevent catastrophic water waste in the event of a pipe rupture or other leak, prevent property and landscape damage, and prevent the loss of valuable plant material due to a non-functioning valve.

6.4 Soil moisture sensors measure soil moisture within the root zone, and can be programmed to shut off the irrigation system when the desired soil moisture level has been reached.

- These are typically located in the ground within specific hydrozone boundaries.
- Soil moisture sensors can be used to override the irrigation schedule when the measured soil moisture content indicates that irrigation is not required.

¹ <https://www3.epa.gov/watersense/products/controltech.html>

² <https://www.irrigation.org/SWAT>

- Strategically placed soil moisture sensors can prevent excessive irrigation from taking place if the programmed run times are higher than required.
- The use of soil moisture sensors can make-up for inefficiencies in the irrigation schedule of both conventional controllers and WBICs.
- For soil moisture sensors to be effective, they must be placed in a position that reliably represents the entire zone and/or system.
- Moisture sensors should be checked periodically to ensure they are still functioning properly.

6.5 Rain sensors shut down the irrigation controller during periods of measurable rainfall.

- Rain sensors are inexpensive and can save significant amounts of water due to rain events during the regular irrigation season.

6.6 Wind sensors shut down the irrigation controller during periods of high wind.

- Wind sensors are useful for overhead irrigation in unprotected areas.

6.7 Freeze sensors prevent the irrigation system from operating in freezing temperatures.

Figure 9-16: Left to right (1) Hunter Solar Sync, (2) Irritrol Climate Logic, (3) Rain Bird WR2 Rain/Freeze Sensor, (4) Toro Precision Soil Sensor, (5) Hunter Flow Sensor (images courtesy of Hunter Industries In, Irritrol, Rain Bird Corporation, and The Toro Company)



7 CONTROLLER REVIEW QUESTIONS

- 7.1 What is the primary function of an irrigation controller?
- 7.2 If used properly what are some of the benefits that an irrigation controller can provide?
- 7.3 What is the difference between an indoor and outdoor irrigation controller?
- 7.4 How is a WBIC different from a conventional controller?
- 7.5 What is a potential application of a central control system?
- 7.6 What are the four parameters needed to program a conventional irrigation controller?
- 7.7 Explain how the seasonal adjustment feature of a conventional controller works?
- 7.8 True or false: All WBICs require the user to enter field data about the irrigation system, plants, and soil to determine the irrigation schedule.
- 7.9 True or false: There are several different approaches used by WBICs for watering frequency and run times.
- 7.10 Where would you look to find a list of WBICs that have been independently certified to ensure that they can adequately meet the watering needs of a landscape without overwatering?
- 7.11 What are some potential issues with WBICs?
- 7.12 Describe how sensors for irrigation controllers interact with the controller schedule.
- 7.13 Describe how soil moisture sensors can be used to improve the irrigation efficiency of both conventional controllers and WBICs.

Section 10:
**BRINGING IT
ALL TOGETHER**





BRINGING IT ALL TOGETHER

Learning Objective

1. Put the tools that you have learned into practice

1 CASE STUDY

Use the information provided to calculate the following for each landscape.

- 1.1 Peak month landscape water budget calculated using peak month ETo, plant factors, and hydrozone areas.
- 1.2 Irrigation water requirement for the peak month, taking into account effective precipitation (rainfall) and irrigation efficiency.
- 1.3 Peak month weekly minimum and maximum irrigation run time in minutes.
- 1.4 Suggest how the peak month weekly irrigation run times could be used to program a conventional irrigation controller.
- 1.5 Explain how you would manage these landscapes to irrigate to a monthly landscape water budget.
- 1.6 Extra credit:
 - Using the traditional landscape determine the volume of mulch and compost needed to sheet mulch the two turf zones.
 - Assume a 2-inch layer of compost and a 4-inch layer of mulch.
 - Using the sustainable landscape:
 - Determine the annual rain catchment potential.
 - Determine the annual graywater production potential.
- 1.7 Assumptions
 - This example is based on the City of Santa Monica garden\garden project, a public demonstration garden that shows that sustainable landscapes are cost-effective, environmentally beneficial, and easy to replicate.
 - The hydrozones have been simplified for the purposes of illustration.
 - The ETo of 4.65 inches is the peak month ETo for CIMIS Zone 1.
 - For this example it is assumed that:
 - Effective precipitation is equal to 25% of precipitation.
 - Irrigation efficiency is equal to low quarter distribution uniformity (DU_{LQ}).
 - There is a dedicated irrigation meter at each site to monitor landscape water use.

Figure 10-1: City of Santa Monica garden\garden project

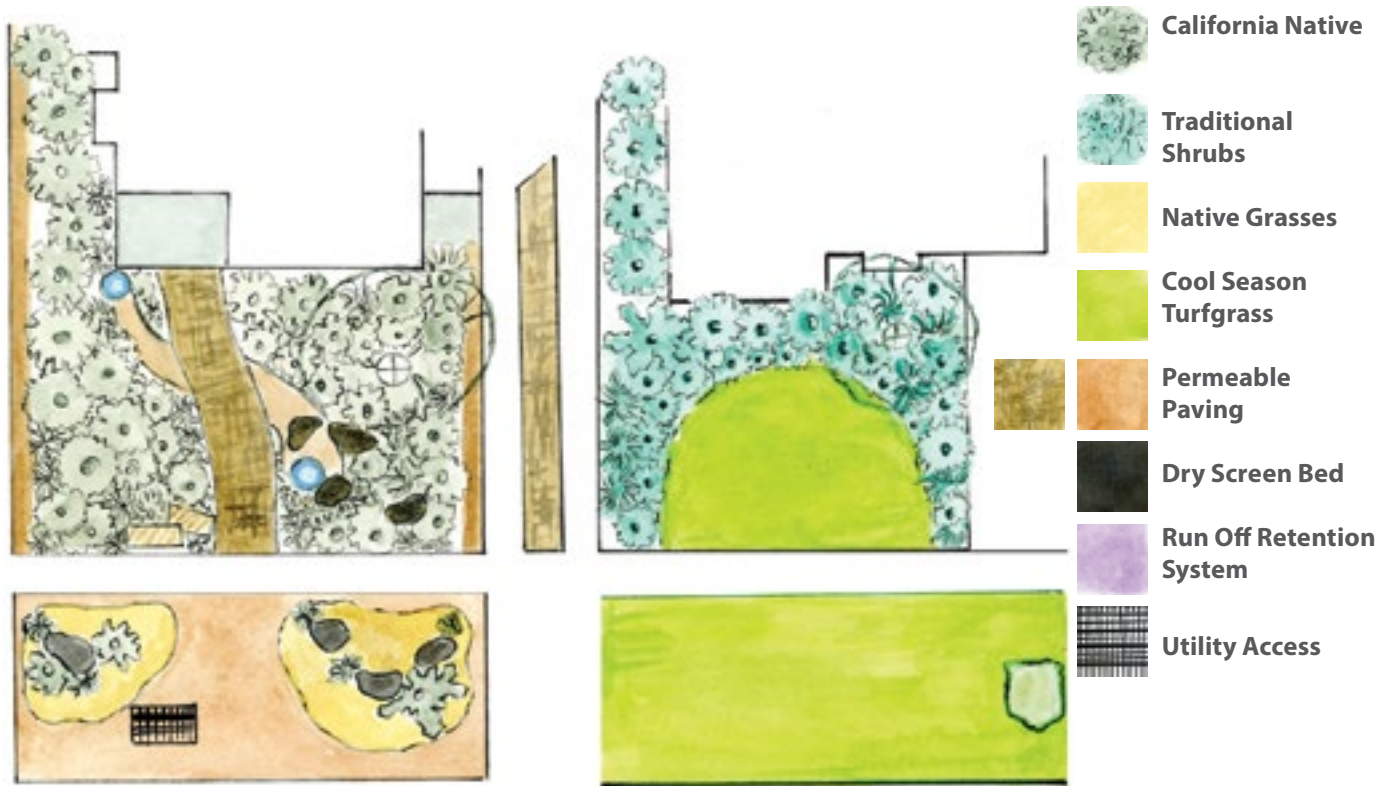

Table 10-1: Traditional landscape hydrozones

Hydrozone	PF	LA (sq ft)	ET _o (inches)	Rainfall (inches)	DU _{LQ}	PR (in / hr)
Turf – front yard	0.8	845	4.65	0.1	0.6	1.85
Turf – parkway	0.8	320	4.65	0.1	0.6	1.85
Shrubs	0.5	530	4.65	0.1	0.6	1.85

- Time to runoff: 5 mins

Table 10-2: Sustainable landscape hydrozones

Hydrozone	PF	LA (sq ft)	ET _o (inches)	Rainfall (inches)	DU _{LQ}	PR (in / hr)
Natives - front yard	0.3	950	4.65	0.1	0.9	0.65
Natives - parkway	0.3	100	4.65	0.1	0.9	0.65

- Time to runoff: 15 mins

Table 10-3: ETo and precipitation by month

Month	ETo (inches)	Rainfall (inches)
January	0.93	3.50
February	1.40	4.30
March	2.48	1.70
April	3.30	0.70
May	4.03	0.40
June	4.50	0.10
July	4.65	0.10
August	4.03	0.10
September	3.30	0.40
October	2.48	0.70
November	1.20	1.70
December	0.62	2.10
Total	32.92	15.80

Table 10-4: Sustainable landscape additional information

Roof area	1,350 sq. ft.
Number of residents	3
Clothes washer average daily per capita water use	9.6 gallons
Shower and bath average daily per capita water use	12.6 gallons

2 PEAK MONTH LANDSCAPE WATER BUDGET SOLUTION

Calculate the peak month landscape water budget calculated using peak month ETo, plant factors, and hydrozone areas.

$$\text{Water Budget} = \text{Weather} \times \text{Plant Type} \times \text{Area}$$

$$\text{Water Budget} = \text{ETo} \times \text{PF} \times \text{LA} \times 0.62$$

Table 10-5: Traditional landscape water budget

Hydrozone	ETo (inches)	PF	LA (sq ft)	Water Budget (gallons)
Turf – front yard	4.65	0.8	845	1,949
Turf – parkway	4.65	0.8	320	738
Shrubs	4.65	0.5	530	764
Total			1,695	3,451

Table 10-6: Sustainable landscape water budget

Hydrozone	ETo (inches)	PF	LA (sq ft)	Water Budget (gallons)
Natives - front yard	4.65	0.3	950	822
Natives - parkway	4.65	0.3	100	86
Total			1,050	908

- 2.1 The sustainable landscape has a smaller total irrigated area due to unirrigated areas such as a dry stream bed and permeable paving.
- 2.2 The lower plant factor of the hydrozones in the sustainable landscape combined with unirrigated areas means that the sustainable landscape has a [water budget that is 74% lower](#) than that for the traditional landscape.

3 IRRIGATION WATER REQUIREMENT FOR THE PEAK MONTH SOLUTION

Calculate the irrigation water requirement for the peak month taking into account effective precipitation (rainfall) and irrigation efficiency.

$$\text{Irrigation Water} = [(\text{Weather} \times \text{Plant Type}) - \text{Rain}] \times \text{Area} \div \text{Efficiency}$$

$$\text{Irrigation Water} = [(\text{ETo} \times \text{PF}) - \text{EP}] \times \text{LA} \div \text{IE} \times 0.62$$

Table 10-7: Traditional landscape irrigation water requirement

Hydrozone	ETo (inches)	PF	EP (inches)	LA (sq ft)	IE	Irrigation Water (gallons)
Turf – front yard	4.65	0.8	0.1 x 0.25	845	0.6	3,226
Turf – parkway	4.65	0.8	0.1 x 0.25	320	0.6	1,222
Shrubs	4.65	0.5	0.1 x 0.25	530	0.6	1,260
Total				1,695		5,708

Table 10-8: Sustainable landscape irrigation water requirement

Hydrozone	ETo (inches)	PF	EP (inches)	LA (sq ft)	IE	Irrigation Water (gallons)
Natives - front yard	4.65	0.3	0.1 x 0.25	950	0.9	897
Natives - parkway	4.65	0.3	0.1 x 0.25	100	0.9	94
Total				1,050		991

- 3.1 The irrigation water requirement of the traditional landscape is higher than the corresponding water budget due to the **poor irrigation efficiency** of the emission devices used.
- 3.2 The irrigation water requirement of the sustainable landscape is slightly higher than the water budget due to the **high irrigation efficiency**.
- 3.3 Taking into account irrigation efficiency and effective precipitation, the sustainable landscape requires **83% less irrigation water** than the traditional landscape.

4 PEAK MONTH WEEKLY IRRIGATION RUN TIMES SOLUTION

Peak month weekly minimum and maximum irrigation run time in minutes.

$$PWR = \text{Weather} \times \text{Plant Type}$$

$$PWR = ETo \times PF$$

$$RTM = 1 \div [0.4 + (0.6 \times DU_{LQ})]$$

$$IWR = PWR \times RTM$$

$$IRT_{MIN} = (PWR \div PR) \times 60$$

$$IRT_{MAX} = (IWR \div PR) \times 60$$

For the solutions provided below:

- Peak month ETo of 4.65 inches per month is equal to 1.05 inches per week.
- PWR, RTM, and IWR are rounded to two decimal places.
- IRT_{MIN} and IRT_{MAX} are rounded up to the nearest minute.

Table 10-9: Traditional landscape peak month weekly irrigation run time

Hydrozone	PWR (inches)	RTM	IWR (inches)	IRT _{MIN} (mins)	IRT _{MAX} (mins)
Turf – front yard	0.84	1.32	1.11	28	36
Turf – parkway	0.84	1.32	1.11	28	36
Shrubs	0.53	1.32	0.70	18	23

Table 10-10: Sustainable landscape peak month weekly irrigation run times

Hydrozone	PWR (inches)	RTM	IWR (inches)	IRT _{MIN} (mins)	IRT _{MAX} (mins)
Natives - front yard	0.32	1.06	0.34	30	32
Natives - parkway	0.32	1.06	0.34	30	32

4.1 The difference between IRT_{MIN} and IRT_{MAX} is larger for the traditional landscape because of the lower irrigation efficiency which results in a higher run time multiplier.

5 CONTROLLER PROGRAMMING SOLUTION

Suggest how the peak month weekly irrigation run times could be used to program a conventional irrigation controller.

- 5.1 The programs below are based on [management decisions](#) and are just one potential solution.
- 5.2 Weekly run time should be [between \$IRT_{MIN}\$ and \$IRT_{MAX}\$](#) .
- 5.3 The schedule programmed should be [continually evaluated and adjusted](#) to maintain plant material to the desired level of appearance.

Table 10-11: Traditional landscape controller program

Hydrozone	Week Run Time (mins)	Number of Days to Irrigate	Daily Run Time (mins)	Number of Cycles Per Day
Turf – front yard	36	3	4	3
Turf – parkway	36	3	4	3
Shrubs	20	2	5	2

- 5.4 Turf irrigated 3 days per week for 4 minutes with three cycles, for a total run time of 12 minutes each day, or 36 minutes each week.
- 5.5 Shrubs irrigated 2 days per week for 5 minutes with two cycles, for a total run time of 10 minutes each day or 20 minutes each week.

Table 10-12: Sustainable landscape controller program

Hydrozone	Week Run Time (mins)	Number of Days to Irrigate	Daily Run Time (mins)	Number of Cycles Per Day
Natives - front yard	30	1	15	2
Natives - parkway	30	1	15	2

- 5.6 California natives irrigated 1 day per week for 15 minutes with two cycles for a total run time of 30 minutes a week.
- 5.7 The relatively long run time for the sustainable landscape hydrozones is due to the much [lower precipitation rate](#) compared to the traditional landscape.

6 MANAGING TO A MONTHLY WATER BUDGET SOLUTION

Explain how you would manage these landscapes to irrigate to a monthly landscape water budget.

6.1 The following solution is just one of many potential solutions.

- Develop a monthly water budget for the landscape.
- Include water rates and calculate potential cost savings.
- Take meter readings at the end of each month to determine actual water usage.
- Compare budgeted water usage to actual water usage.
- If water usage exceeds the budget find out why and fix the issue. The water budgets shown are the irrigation water requirements based on monthly historical average ETo, rainfall, and irrigation efficiency.
- The monthly water budget examples shown below are based on the ETo and rainfall numbers provided in Table 10-3.
- Effective precipitation (rainfall) is calculated as 25% of precipitation for the month.
- In the real world it would be more accurate to update the planned budget using actual ETo and precipitation at the end of each month.
- The water usage numbers are shown in gallons, when in the real world they would be billed in thousands of gallons or CCF.
- The assumed tier 1 cost of water is \$5.29 per 1,000 gallons up to the water budget and the assumed tier 2 cost of water is \$6.70 per 1,000 gallons for water usage above the budget.
- Many water providers bill based on a water budget. In this case it would be more meaningful to align the water budget calculation with that used by the water provider.
- Assumed water usage numbers are used for the purposes of illustration.
 - Water usage for the traditional landscape is based on operation with a conventional irrigation controller with a typical residential watering pattern as illustrated in Figure 8-2
 - Water usage for the sustainable landscape is based on watering with a weather based irrigation controller that is watering more closely to the calculated budget.

6.2 The table and figures below show that the cost of watering the traditional landscape to be \$335 per year, compared to only \$34 for the sustainable landscape.

- The inefficient irrigation of the traditional landscape results in potential cost savings of \$144, which represents 43% of the total annual water cost.
 - The cost of purchasing and installing a weather based irrigation controller could be repaid in just a few years.
- Converting the traditional landscape together with a weather based irrigation controller would save about \$300 annually.
 - Local utility sponsored rebate programs could significantly reduce the cost of the conversion, e.g. a \$1.00 per square foot turf conversion rebate would contribute \$1,165 to the process.
 - The additional benefits of sustainable landscaping over traditional landscapes make conversion a compelling solution.

Table 10-13: Traditional landscape monthly water budget

Month	Water Budget / Irrigation Water Requirement (gallons)	Assumed Actual Water Usage (gallons)	% Over / Under Budget	Cost of Water (\$)	Cost Savings Potential (\$)
January	0	0		0	0
February	54	0		0	0
March	2,323	5,000	215%	32	19
April	3,775	5,000	132%	30	9
May	4,810	5,000	104%	28	1
June	5,522	5,000	91%	28	-3
July	5,708	7,000	123%	41	9
August	4,941	7,000	142%	42	14
September	3,907	7,000	179%	43	22
October	2,761	7,000	254%	45	30
November	740	7,000	946%	48	44
December	0	0		0	0
Total	34,541	55,000	159%	335	144

Figure 10-2: Traditional landscape monthly water budget vs water usage

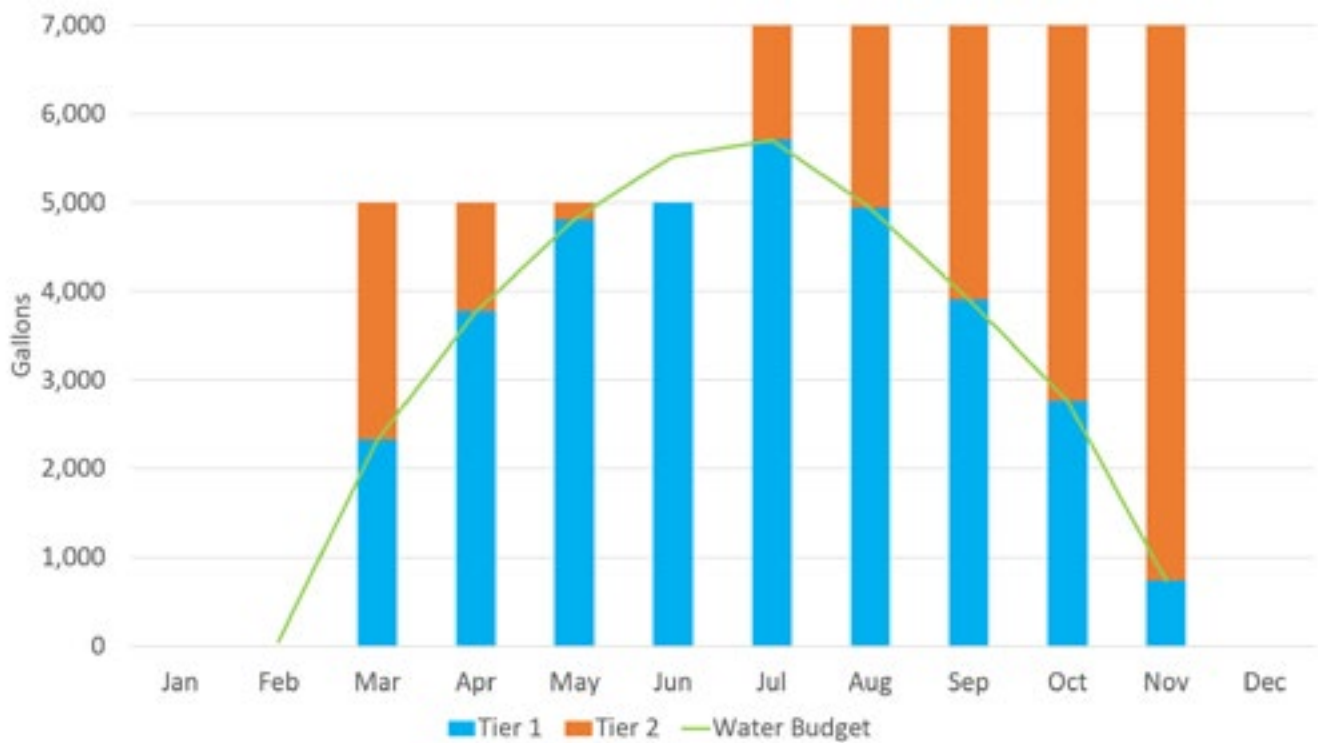
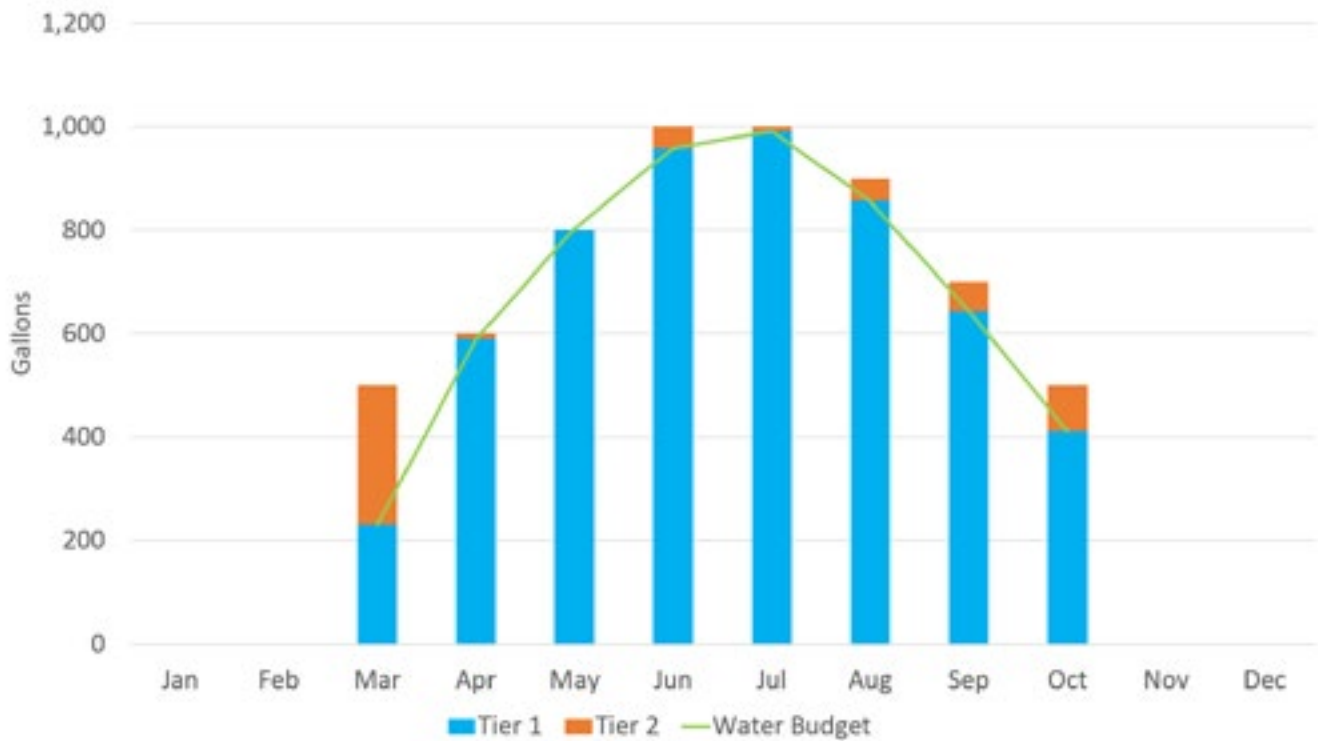

Table 10-14: Sustainable landscape monthly water budget

Month	Water Budget / Irrigation Water Requirement (gallons)	Assumed Actual Water Usage (gallons)	% Over / Under Budget	Cost of Water (\$)	Cost Savings Potential (\$)
January	0	0		0	0
February	0	0		0	0
March	231	500	217%	3	2
April	590	600	102%	3	0
May	802	800	100%	4	0
June	958	1,000	104%	6	0
July	991	1,000	101%	6	0
August	856	900	105%	5	0
September	644	700	109%	4	0
October	412	500	121%	3	1
November	0	0		0	0
December	0	0		0	0
Total	5,484	6,000	109%	34	4

Figure 10-3: Sustainable landscape monthly water budget vs water usage



7 EXTRA CREDIT SOLUTIONS

7.1 Volume of mulch and compost needed to sheet mulch the two turf zones of the traditional landscape.

- Volume in cubic feet rounded to the nearest cubic foot.
- Volume in cubic yards rounded to one decimal place.

Table 10-15: Traditional landscape compost volume

Hydrozone	Area (sq ft)	Depth (inches)	Volume (cubic feet)	Volume (cubic yards)
Turf – front yard	845	2	141	5.2
Turf – parkway	320	2	53	2
	1,165		194	7.2

Table 10-16: Traditional landscape mulch volume

Hydrozone	Area (sq ft)	Depth (inches)	Volume (cubic feet)	Volume (cubic yards)
Turf – front yard	845	4	282	10.4
Turf – parkway	320	4	107	4
	1,165		389	14.4

7.2 Annual rain catchment potential for the sustainable landscape.

- Rain catchment potential = area in square feet x rainfall in inches x 0.62

Table 10-17: Sustainable landscape annual rain catchment potential

Roof Area (sq ft)	Annual Precipitation (inches)	Annual Rain Catchment Potential (gallons)
1,350	15.8	13,225

- The annual rain catchment potential of 13,225 gallons is equal to 241% of the annual water budget of 5,484 gallons. In addition, the landscape itself also receives rainfall.
- However, precipitation is focused on the winter months when ETo is relatively low.
- Directing rainwater into the landscape would ensure that the soil moisture reservoir remains at field capacity into the spring and would help to delay the point at which irrigation is required.
- Adding a cistern would go further to reduce the supplemental irrigation requirement.

7.3 Annual graywater production potential for the sustainable landscape.

- Graywater production potential = average daily per capita water use in gallons x number of residents x 365 days

Table 10-18 Sustainable landscape annual graywater production potential

Fixture	Average Daily Per Capita Water Use (gallons)	Number of Residents	Annual Graywater Production Potential (gallons)
Clothes washer	9.6	3	10,512
Shower and bath	12.6	3	13,797
	22.2		24,309

- The annual graywater production potential of 24,309 gallons is equal to 443% of the annual water budget of 5,484 gallons.
- Graywater production occurs throughout the year.
- Graywater irrigation techniques are typically relatively crude when compared to an efficient drip irrigation system.
- There should be more than enough graywater to irrigate the landscape successfully.
- Including a rainwater cistern would provide the opportunity flush the soil regularly to prevent salt buildup from the graywater.

8 BRINGING IT ALL TOGETHER REVIEW

- 8.1 Know where your water comes from and be aware of local rebate programs.
- 8.2 Be able to use a water meter for tracking water usage and leak detection.
- 8.3 Consider landscapes as mini-watersheds that reside within a larger watershed.
- 8.4 Healthy living soils are the foundation of sustainable landscapes.
- 8.5 Reference evapotranspiration and climate appropriate plants to determine how much water the landscape needs.
- 8.6 A water budget is an estimate of how much water is needed to maintain a healthy landscape for a given time period.
- 8.7 High-efficiency irrigation systems and landscape water management are important components of conserving water supplies.
- 8.8 Regular maintenance is essential to the proper operation of an efficient irrigation system over time.
- 8.9 The purpose of an irrigation system audit is to assess how effective an irrigation system is at applying water to a specific hydrozone.
- 8.10 Irrigation scheduling involves developing a plan for the operation of the irrigation system.
- 8.11 If used properly, irrigation controllers can efficiently manage the application of irrigation water and provide reliable operation of irrigation systems at any time, day or night.

Appendix:

**AUDIT FORM
& FORMULA SHEET**





Auditor Name: _____ Date: _____

Certifying Organization: _____

Audit Location: _____

- ① The irrigation audit must be conducted as part of a QWEL workshop or independently supervised by a QWEL certified professional. Calculations must be completed independently. Completed forms must be submitted to the QWEL Professional Certifying Organization through which you are obtaining the QWEL certification.
- ② Complete site information, evaluation, and basic system tune-up prior to irrigation system testing.
 - Only conduct an irrigation audit if the irrigation system is determined to be in good working order.
- ③ Irrigation System Testing Procedures
 - Draw a diagram of the test area including dimensions, head locations, and catch can locations.
 - Only conduct an irrigation audit on overhead irrigation systems if the wind speed is 5 mph or less.
 - Run zone to be tested and mark spray bodies with flags.
 - Place catch cans in zone to be tested.
 - Ensure all cans are of the same size and shape.
 - Use a minimum of 24 catch cans and a number of cans that can be divided by four.
 - Leave a space of about 2 feet between a spray body and a catch can.
 - Layout catch cans in a uniform grid.
 - Space cans approximately 5 – 8 feet on center for fixed and rotary spray sprinklers.
 - Space cans approximately 10 – 20 feet on center for rotors.
 - Pull flags before running test as they will obstruct the path of the spray.
 - Run the irrigation zone for a sufficient amount of time to collect a minimum volume of water of 20 ml. Typically 5 – 10 min for fixed spray sprinklers and 10 – 30 mins for rotors and rotating sprinklers.
 - If the test area covers more than one station the run time for each station must be adjusted to achieve a matched precipitation rate across the test area.
 - Measure and record the amount of water in each catch can.
 - Use scale on catch can if available to measure volume of water in ml or depth of water in inches or centimeters.
 - If no scale is available pour water into a graduated cylinder with a ml scale.
 - For catch cans with straight sides and a flat bottom, simply measure the depth of water in inches or centimeters using a ruler.
 - Ensure that catch cans are numbered on the diagram so that the location of the measurements is known as this may help to identify issues with the irrigation system.
- ④ Calculate the low quarter distribution uniformity (DU_{LQ}):
- ⑤ Calculate the net precipitation rate (PR_{NET}):
- ⑥ Use the DU_{LQ} and PR_{NET} to determine a basic irrigation schedule for the test area.



Date: _____

Auditor				
First Name: _____	Phone Number: _____			
Last Name: _____	Email: _____			
Test Area				
Site Name: _____	Test Area Name: _____			
Site Type: _____	Test Area Size: _____ sq ft			
Soil Type: _____	Plant Material: _____			
Microclimate: _____	Root Depth: _____ inches			
Slope: _____	Plant Factor (PF): _____			
Time to Runoff: _____ min	ETo for 1 Week: _____ inches			
Irrigation System				
Water Source: _____	Meter Type: _____			
Static Pressure: _____ psi	Meter Size: _____ inches			
Dynamic Pressure: _____ psi	Meter Units _____			
Irrigation Type: _____	Backflow: _____			
Options				
<u>Site Type</u>	<u>Microclimate</u>	<u>Water Source</u>	<u>Meter Type</u>	<u>Backflow Device</u>
Residential	Shade	Municipal Well	Dedicated irrigation	Reduced pressure assembly
Commercial	Part shade	Recycled water	Mixed use	Double check valve
	Full sun	Graywater		Anti-siphon valve
	Extreme heat	Rain water		(atmospheric breaker)
<u>Soil Type</u>			<u>Meter Size</u>	Pressure vacuum breaker
Sandy			5/8", 1", 1.5", 2",	None
Loam	<u>Slope</u>	<u>Irrigation Type</u>	3", 4", 5", 6"	
Silt	Flat	Spray sprinklers		
Clay loam	Slight	Rotating sprinklers	<u>Meter Units</u>	
Clay	Moderate	Rotors	Gallons	
	Steep		CCF	



Auditor Name: _____

Date: _____

Include: test area dimensions, head locations, catch can locations, catch can numbers, north arrow.

Sprinkler = ○

Catch can = ✕

A large empty rectangular box for drawing the test area diagram.



Auditor Name: _____

Date: _____

Check relevant boxes			
Priority	High	Low	Fixed
Mixed hydrozone			
Needs mulch			
High pressure			
Low pressure			
Valve malfunction			
Broken pipes			
Unmatched precipitation rates			
Mixed emission devices			
No head-to-head coverage			
Uneven head spacing			
Excessive overspray			
Broken or missing nozzles			
Tilted heads			
Heads below grade			
Blocked spray			
Leaking seals			
Clogged nozzles			
Low head drainage			
Heads not rotating			
Observations			

Auditor Name: _____

Date: _____

Catch Can Number	Catch Can Volume / Depth	Low Quarter
1		
2		
3		
4		
5		
6		
7		
8		
9		
10		
11		
12		
13		
14		
15		
16		
17		
18		
19		
20		
21		
22		
23		
24		
25		
26		
27		
28		
29		
30		
31		
32		
33		
34		
35		
36		
Sum		
Average		

Instructions

- Enter catch can volume (ml) in the second column of the table.
- Enter the depth in inches for cans with straight sides and a flat bottom.
- Identify catch cans in the low quarter and enter the volume (or depth) of these cans in the third column of the table.
- Enter the sum of each column at the bottom of the table.
- Divide the sum of each column by the number of cans in the column to calculate the average for all cans and for the low quarter.
- DU_{LQ}: Divide the average catch volume of the low quarter by the average for all cans. Round to two decimal points.
- PR_{NET}: Use the correct formula depending on whether using volume in ml or depth in inches or centimeters. Round to two decimal points.

Catch Can Type	Throat Area (sq in)
Cal Poly / ITRC / DWR	16.25
Texas A & M System	16.61
Utah State University	12.94



Catch Can Type: _____

Throat Area: _____ sq in

Test Run Time: _____ min

DU_{LQ} Calculation

$$DU_{LQ} = \frac{\text{Average catch volume of low quarter}}{\text{Average catch volume of all cans}} = \frac{\quad}{\quad} = \quad$$

PR_{NET} Calculation using volume in ml

$$PR_{NET} = \frac{\text{Average volume of all cans} \times 3.66}{\text{Test run time} \times \text{Catch can throat area}} = \frac{\quad \times 3.66}{\quad \times \quad} = \quad \text{in / hr}$$

PR_{NET} Calculation using depth in inches or centimeters

$$PR_{NET} = \frac{\text{Average depth of all cans} \times 60}{\text{Test run time}} = \frac{\quad \times 60}{\quad} = \quad$$



Auditor Name: _____

Date: _____

Plant Water Requirement (PWR) - use ETo for 1 week					
PWR	=	ETo x PF			
	=	_____ x _____	= _____ in / wk		
Run Time Multiplier (RTM) - used to adjust time for irrigation system inefficiencies					
RTM	=	$1 \div [0.4 + (0.6 \times DU_{LQ})]$			
	=	$1 \div [0.4 + (0.6 \times \underline{\hspace{2cm}})]$	= _____		
Irrigation Water Requirement (IWR)					
IWR	=	PWR x RTM			
	=	_____ x _____	= _____ in / wk		
Minimum and Maximum Weekly Irrigation Run Time (IRT_{MIN} and IRT_{MAX})					
IRT _{MIN}	=	$(PWR \div PR_{NET}) \times 60$			
	=	$(\underline{\hspace{2cm}} \div \underline{\hspace{2cm}}) \times 60$	= _____ min / wk		
IRT _{MAX}	=	$(IWR \div PR_{NET}) \times 60$			
	=	$(\underline{\hspace{2cm}} \div \underline{\hspace{2cm}}) \times 60$	= _____ min / wk		
Daily Run Time		Number of Days Per Week to Irrigate (Mature Plants)			
<ul style="list-style-type: none"> ● Weekly IRT is a management decision between weekly IRT_{MIN} and IRT_{MAX} ● Number of days to irrigate is a management decision. Use the table for guidance. 		Weekly ETo	Cool 0 - 0.5 "	Warm 0.6 - 1.0"	Hot above 1"
		Turf	1 - 2 days	2 - 3 days	3 - 7 days
		Annuals	2 - 3 days	3 - 5 days	4 - 7 days
		Shrubs	Every 2 weeks	Every week	2 - 4 days
		Trees	None	Every 2 months	Every month
Daily IRT	=	(Weekly IRT ÷ Number of Days to Irrigate)			
	=	$(\underline{\hspace{2cm}} \div \underline{\hspace{2cm}})$	= _____ min		
Cycles Per Day - round up to the next whole number					
Cycles Per Day	=	(Daily IRT ÷ Time to Runoff)			
	=	$(\underline{\hspace{2cm}} \div \underline{\hspace{2cm}})$	= _____		
Run Time Per Cycle - round up to the next whole minute.					
Run Time Per Cycle	=	(Daily IRT ÷ Cycles Per Day)			
	=	$(\underline{\hspace{2cm}} \div \underline{\hspace{2cm}})$	= _____		



QWEL EXAM FORMULA SHEET

<p>Conversion</p> <p>1 foot = 12 inches</p> <p>1 cubic foot (CF) = 7.48 gallons</p> <p>100 CF = 1 CCF = 748 gallons</p>	<p>Geometry - Area</p> <p>Square or rectangle = width x length</p> <p>Triangle = $\frac{1}{2}$ x base x height</p> <p>Circle = $3.14 \times \text{radius}^2$</p>
<p>Water Budget Formulas</p> <p>Water Budget = $E_{To} \times PF \times LA \times 0.62$</p> <p>Irrigation Water = $[(E_{To} \times PF) - EP] \times LA \div IE \times 0.62$</p>	
<p>Precipitation Rate & Distribution Uniformity Formulas</p> <p>PR_{GROSS} for spray and drip = $(96.3 \times GPM) \div HA$</p> <p>$PR_{GROSS}$ for dripline laid out in a grid = $(231.1 \times GPH) \div (\text{Emitter spacing} \times \text{Row spacing})$</p> <p>$DU_{LQ}$ = Average catch volume/depth of low quarter \div Average catch volume/depth of all cans</p> <p>PR_{NET} using volume in ml = $(\text{Average catch volume of all cans} \times 3.66) \div (\text{Test run time} \times \text{Catch can throat area})$</p> <p>$PR_{NET}$ using depth in inches or centimeters = $(\text{Average depth of all cans} \times 60) \div \text{Test run time}$</p>	
<p>Scheduling Formulas</p> <p>$PWR = E_{To} \times PF$</p> <p>$RTM = 1 \div [0.4 + (0.6 \times DU_{LQ})]$</p> <p>$IWR = PWR \times RTM$</p> <p>$IRT_{MIN} = (PWR \div PR_{NET}) \times 60$</p> <p>$IRT_{MAX} = (IWR \div PR_{NET}) \times 60$</p>	

